

**STAMFORD UNIVERSITY BANGLADESH
DEPARTMENT OF CIVIL ENGINEERING**



**ANALYSIS AND DESIGN OF A TWELVE
STORIED HOSPITAL BUILDING SUBJECTED
TO LATERAL LOAD**

**M A Khan Mamun
ID # CEN 058 08961**

**Nazmul Ahsan Shawn
ID # CEN 058 08952**

**Rubayet Roshafi
ID # CEN 058 08946**

**Md. Rahadul Hasan Tomal
ID # CEN 058 08898**

SEPTEMBER 2019

ANALYSIS AND DESIGN OF A TWELVE STORIED HOSPITAL BUILDING SUBJECTED TO LATERAL LOAD

A Project & Thesis by

M A Khan Mamun
ID # CEN 058 08961

Nazmul Ahsan Shawn
ID # CEN 058 08952

Rubayet Roshafi
ID # CEN 058 08946

Md. Rahadul Hasan Tomal
ID # CEN 058 08898

Supervised by

Prof. Dr. Ali Ahmed
Professor
Department of Civil Engineering

In partial fulfillment of the requirements for the degree of Bachelor
of Science (B.Sc.) in Civil Engineering

SEPTEMBER 2019



STAMFORD UNIVERSITY BANGLADESH
DEPARTMENT OF CIVIL ENGINEERING
51, SIDDESWARI ROAD, DHAKA - 1217

The project and thesis titled “*Analysis and Design of a Twelve Storied Hospital Building Subjected to Lateral Load*” Submitted by M A Khan Mamun who’s ID: CEN 058 08961 and Batch No.58D, Nazmul Ahsan Shawn who’s ID: CEN 058 08952 and Batch No.58C, Rubayet Roshafi who’s ID: CEN 058 08946 and Batch No.58B, and Md.Rahadul Hasan Tomal who’s ID: CEN 058 08898 and Batch No.58C of the Department of Civil Engineering has been examined thoroughly and accepted in partial fulfillment of the requirements for the degree of Bachelor of Science in Civil Engineering on September 26, 2019.

(Dr. Ali Ahmed)

Supervisor

Professor

Department of Civil Engineering

Stamford University Bangladesh

DECLARATION

We, M A Khan Mamun, Nazmul Ahsan Shawn, Rubayet Roshafi and Md. Rahadul Hasan Tomal, the student of B.Sc. in Civil Engineering hereby solemnly declare that the works presented in this thesis & project has been carried out by us and has not previously been submitted to any other University / College / Organization for any academic qualification / certificate / diploma / degree etc.

We warrant that the present work does not breach any copyright law.

We further undertake to indemnify the University against any loss or damage arising from breach of the foregoing obligations.

M A Khan Mamun
ID: CEN 058 08961
Batch: 58 D

Nazmul Ahsan Shawn
ID: CEN 058 08952
Batch: 58 C

Rubayet Roshafi
ID: CEN 058 08946
Batch: 58 B

Md.Rahadul Hasan Tomal
ID: CEN 058 08898
Batch: 58 C

DEDICATION

Every challenging work needs self-efforts as well as guidance of elders especially those who were very close to our heart,

Our humble effort we would like to Dedicate to our sweet and loving

Father & Mother

Whose affection, love, encouragement and prays of day and night make us able to get such success and honor,

Along with all hard working and respected

Teachers

TABLE OF CONTENTS

	Title	Page
	LIST OF FIGURES	i
	LIST OF TABLES	iii
	ACKNOWLEDGEMENT	v
	ABSTRACT	vi
 CHAPTER 1: INTRODUCTION 		
1.1	General	1
1.2	Background of the study	1
1.3	Objective of the Study	3
1.4	Scopes/limitation of the Study	3
 CHAPTER 2: LITERATURE REVIEW 		
2.1	General	4
2.2	Edge Supported Structure	4
2.3	Different components of concrete structure of a building	5
2.3.1	Beam	5
2.3.2	Column	6
2.3.3	Slabs	6
2.3.4	Foundation	7
2.3.5	Stair case	8
2.3.5	Water Tank	8
2.4	Reinforcing general	9
2.5	Gravity Loads	10
2.5.1	Dead Loads	10
2.5.2	Live Loads	10
2.6	Lateral Loads	11
2.6.1	Wind Loads	11

2.7 Earthquake Loads	15
2.7.1 Seismic Zoning Map	16
2.8 Effects of Earthquakes on Reinforced Concrete Buildings	17
2.8.1 Selection of Lateral Force Method	18
2.8.2 Seismic Dead Load	18
2.8.3 Equivalent Static Force Method	19
2.9 Analysis and Design Basis	20
2.9.1 Analysis Software	20

CHAPTER 3: DESCRIPTION OF THE PROPOSED BUILDING

3.1 Introduction	25
3.2 Description of Different Floors	26

CHAPTER 4: EARTHQUAKE AND WIND LOADS

4.1 General	40
4.2 Determination of Dead Load	40
4.2.1 Water tank on roof	40
4.3 Earthquake Load Calculation	40
4.4 Wind Load Calculation	43

CHAPTER 5: STUDY METHOD AND ANALYSIS OF THE BUILDING

5.1 Introduction	45
5.2 Study Procedure	45
5.3 Design Data and Specifications considered in this Study	48
5.4 Result of 3D Model Analysis	48

CHAPTER 6: DESIGN OF SLAB

6.1 Introduction	56
6.2 Design of slab	57

6.2.1 Design Data	57
6.2.2 Check of effective depth of the slab	58
6.2.3 Calculation of reinforcement	58

CHAPTER 7: DESIGN OF BEAM

7.1 Introduction	63
7.2 Design of Exterior Beam	64
7.2.1 Design data	64
7.2.2 Maximum Steel Ratio	64
7.2.3 Reinforcement Calculation	65
7.2.4 Seismic Design Check	67
7.2.5 Design of seismic hoops	69

CHAPTER 8: DESIGN OF COLUMN

8.1 Introduction	71
8.2 Design of column C-1	72
8.2.1 Design of Tie Bar of Column for a Special Moment Resisting Frame	74

CHAPTER 9: DESIGN OF STAIR

9.1 Introduction	78
9.2 Design of Stair case	78

CHAPTER 10: DESIGN OF SHEAR WALL

10.1 Introduction	83
10.2 Design of shearwall	83

CHAPTER 11: DESIGN OF WATER RESERVOIR

11.1 Introduction	88
11.2 Determination of Water Consumption	88

11.2.1 Design of Base Slab	90
11.2.2 Design of Cover Slab	91
11.2.3 Design of Sidewall	92
11.2.4 Reinforcement Details of Underground Water Reservoir	93

CHAPTER 12: DESIGN OF WATER TANK

12.1 Introduction	95
12.2 Design of water consumption	95
12.2.1 Wall Design	95
12.3 Reinforcement details of water tank	100

CHAPTER 13: CONCLUSIONS & RECOMMENDATIONS

13.1 Conclusions	101
13.2 Recommendation for future work	101
REFERENCES	102
APPENDIX	103

LIST OF FIGURES

Figure no.	Title of Figure	Page
2.1	An edge supported building structure under construction	4
2.2	Division in earthquake zones of Bangladesh	16
2.3	Earthquake effect in a building	17
2.4	Mash of building model	22
3.1	Basement floor plan	27
3.2	Ground floor plan	28
3.3	1 st floor plan	29
3.4	2 nd floor plan	30
3.5	3 rd floor plan	31
3.6	4 th floor plan	32
3.7	5 th floor plan	33
3.8	6 th to 9 th floor plan	34
3.9	10 th floor plan	35
4.1	Wind load application on the building across short direction	43
5.1	3D view of structural frame model of the proposed building	46
5.2	Define frame section of the proposed building	47
5.3	Define load case of the proposed building	47
5.4	Bending Moment Diagram of Columns and Beams on 5-5 Grid (kip-ft)	49
5.5	Bending Moment Diagram of Columns and Beams on C-C Grid (kip-ft)	50
5.6	Bending Moment Diagram of Columns and Beams on 7-7 Grid (kip-ft)	51
5.7	Shear Force Diagram of Beams on 5-5 Grid (kips)	52
5.8	Shear Force Diagram of Beams on C-C Grid (kips)	53
5.9	Axial Force Diagram of columns on 7-7 Grid (kips)	54
5.10	Axial Force Diagram of columns on C-C Grid (kips)	55

6.1	Panel layout plan	57
6.2.1	Moment At Panel (X-direction)	59
6.2.2	Moment At Panel (Y-direction)	60
6.3	Reinforcement detailing of slab panel S1	61
6.4	Detail of corner Reinforcement	62
7.1	Beam layout plan	63
7.2	Maximum design moment of Beam(from ETABS result file)	64
7.3	Details Reinforcement of Interior Beam FB	70
8.1	Column layout plan	71
8.2	Maximum axial force diagram of column C1 of grid 7-7 (kip)	72
8.3	Maximum bending moment diagram of column C1 of grid 7-7 (kip-ft)	72
8.4	Sectional diagram of column C ₁	73
8.5	Distribution of seismic ties in column C ₁	76
8.6	Longitudinal Cross-section of column C ₁	77
9.1	Plan view of stair case	78
9.2	Plan view of stair	81
9.3	Reinforcement details of stair section A-A	81
9.4	Reinforcement details of stair section B-B	82
10.1	Bending moment shear wall grid 8-8	83
10.2	Shear for shear wall grid 8-8	84
10.3	Axial force for shear wall grid 8-8	84
10.4	Reinforcement and cross-sectional details of shear wall	88
11.1	Reinforcement details of cover slab.	93
11.2	Reinforcement details of base slab	94
11.3	Reinforcement details of wall of the water reservoir	94
12.1	Reinforcement details of wall of the tank.	100

LIST OF TABLES

Table no.	Title of Table	Page
2.1	Summary of Minimum ASTM strength Requirements	10
4.1	Seismic Zone Coefficient, Z (BNBC, Table- 6.2.22)	40
4.2	Structure Importance Coefficient, I & I' (BNBC, Table-6.2.23)	41
4.3	Earthquake load at the story level (zone-II).	42
4.4	Estimation of design wind pressure	44
6.1	Detail of reinforcement arrangement of slab panel S1	61
8.1	Detail of sectional dimension and reinforcement arrangement of column C1	75

ACKNOWLEDGEMENT

The Project and thesis work titled “ Analysis and Design of a Twelve Storied Hospital Building Subjected to Lateral Load” has been conducted in partial achievement of the requirements for the degree of Bachelor of Science (B. Sc.) in Civil Engineering. This significant work has come to life due to the categorical help and collaboration in different ways by many people. We express our deep appreciation and gratefulness to them for their assistance in preparation of this project and thesis. However, all praises belongs to the Almighty of Allah Subhana WaTa’la for His mercy, blessing and guidance in preparation of our project and thesis.

We are indebted to our supervisor, Prof. Dr. Ali Ahmed, of the Project and Thesis hearing us patiently, providing us all the suggestions and recommendations and showing us the right way to complete our graduation end Project and Thesis. We also would like to express our deep gratitude and appreciation for his full time supervision to prepare this project and thesis work.

We are also grateful to our departmental chairman Prof. Dr. B.C. Basak and all of our teachers of the department for their collaboration and enthusiastic teaching for the achievement of the degree of B.Sc. in Civil Engineering.

ABSTRACT

It is very essential to consider the effects of lateral loads induced from blowing wind and occurring earthquakes in the design of reinforced concrete structures, especially for high-rise Buildings. When any design specifications and codes are not available in Bangladesh National Building Code (BNBC 1993), it is recommended to use ACI USD codes in practice. Thus, some cases of earthquakes which are found to be dominant and even more critical than wind effects need to special care in analysis and design and those can be treated with the ACI design codes.

Depend on some factors defined by codes, in this study the wind and earthquake effects are studied in the building analysis according to the BNBC 1993 and specific design and detailing are done using ACI 318 code. In general, BNBC codes are implied for wind and earthquake load analysis and discussed to show all factors affecting in the design. A computer 3D model is generated to analyze the building frame behavior under wind pressure as defined in BNBC 1993 as well as equivalent static load method for earthquake loads. Nonlinear static analysis of building located at Dhaka of seismic zone II performed creating finite element 3D model of actual building size and results are discussed for the purpose of showing the effects of different facts. Few conclusions are drawn and several recommendations are suggested to improve the resistance of the structural systems of the building to resist efficiently the lateral loads.

CHAPTER 1

INTRODUCTION

1.1 General

Bangladesh is a developing country. 70% people of Bangladesh are living in villages but a large amount of people rushed in to towns to find their work and shelters. Recently our government has taken initiatives to develop the villages and have the similar facilities as in towns. But still the density of population in town is increasing day by day; however, accommodation for those crowded is not sufficient. So, we need to build the high rise building instead of low-rise buildings. Most of the high-rise buildings are being built in Dhaka city and other in divisional cities in our country. Now a day, we construct residential cum commercial buildings in Dhaka city to facilitate both commercial and residential services to the residence and the people taking entry from other places.

Susceptibility of major earthquake is also increasing day by day. In the last sixty years period, we have faced many destructive and non-destructive earthquakes. So, the importance of seismic resistant design is increasing to remain the necessary safety measure for saving lives. In order to do that we have to take the wind and earthquake loads in design considerate on. In accordance to the BNBC code, Bangladesh territory is divided into three seismic zones. Definition of seismic zone for a building site is based on the location of the site on the seismic zoning map. As for example, the position of Khulna is in zone I, Dhaka is in zone II and Mymensingh is in zone III (Figure 2.2).

1.2 Background of study

Now a day residential high-rise buildings are constructed not only in Dhaka city but also in divisional cities of our country. These types of high-rise buildings are being affected by lateral loads. The structural systems of tall buildings must carry vertical gravity loads in addition to the lateral loads such as wind load and earthquake load. Lateral loads are always applied horizontally. Wind load are particularly important in the design of large structures, such as tall building, that have large open interiors and wall in which large opening may occur. Wind load acts directly on the structure. Variation of wind velocity with height must be considered in the design of tall structure. If the wind effect is not

properly considered in the structure will produce lateral deflection, i.e. sway and the resident of the structure will feel dizziness, headache and other uncomfortable feeling.

Severity of ground shaking at a given location during an earthquake can be minor, moderate and strong. Relatively speaking, minor shaking occurs frequently; moderate shaking occasionally and strong shaking rarely. The engineers do not attempt to make earthquake proof buildings that will not get damaged even during the rare but strong earthquake; such building will be too robust and also too expensive. Instead, the engineering intention is to make buildings earthquake resistant; such buildings resist the effect of ground shaking, although they may get damaged severely but would not collapse during the strong earthquake. Thus, safety of people and contents are assured in earthquake resistant buildings, and thereby a disaster is avoided. This is a major objective of seismic design codes throughout the world.

The conventional approach to earthquake resistant design of buildings depends upon providing the building with strength, stiffness and inelastic deformation capacity which are great enough to withstand a given level of earthquake-generated force. This is generally accomplished through the selection of an appropriate structural configuration and the careful detailing of structural members, such as beams and columns and the connections between them.

The total lateral force is distributed to floors over the entire height of the structure in such a way as to approximate the distribution of forces obtained from a dynamic analysis. The lateral load resisting systems for earthquake loads are similar to those for wind loads. Both are designed as if they are horizontally applied to the structural system. The wind load is considered to be more of a constant force while the earthquake load is almost instantaneous. The wind is an external force, the magnitude of which depends upon the height of the building, the velocity of the wind and amount of surface area that the wind "attacks". The magnitude of earthquake load depends upon the mass of the structure, the stiffness of the structural system and the acceleration of the surface of the earth. Since the maximum load that will occur during life of a structure is uncertain, the engineer must provide an adequate structure.

In this study, edge supported floor system will be analyzed and designed considering all factors regarding lateral loads concept and conventional procedures.

1.3 Objective of the study

The objectives of the study are as follows:

- To learn how to prepare plan for residential building.
- To learn how to perform structural analysis by ETABS.
- To ensure safety against seismic force of multi storied building.
- To learn how to design different structural elements of high rise building as per BNBC and ACI codes.

1.4 Scopes/ limitations of the study

- Earthquake and wind loads are considered in the structural analysis using ETABS.
- A few columns and beams have been designed.
- Edge supported floor systems were considered.
- Few components of the building have been designed by USD method.
- Static analysis of the structure by ETABS was performed.

CHAPTER 2

LITERATURE REVIEW

2.1 General

Design of structural members and structural system of reinforced concrete is a problem distinct from but closely related to analysis. Strictly speaking, it is very difficult to analyze and design exactly a concrete structure. Fortunately, it is possible to make a few fundamental assumptions, which make the design of reinforced concrete, quite simple, if not easy. A problem unique to the design of reinforced concrete structures is the need to detail each member throughout. For concrete structures, we must determine not only the area of longitudinal and lateral reinforcement required in each member, but also the way to best arrange and connect the reinforcement to insure acceptable structural performance.

2.2 Edge Supported Structure

When a slab is supported on beam, it is called beam structure. A beam is a structural element that is capable of withstanding load primarily by resisting bending. Beams are traditionally descriptions of building or civil engineering structural elements.



Figure 2.1: An edge supported building structure under construction

2.2.1 Types of Beams

In engineering, beams are of several types:

1. Simply supported - a beam supported on the ends which are free to rotate and have no moment resistance.
2. Fixed - a beam supported on both ends and restrained from rotation.
3. Over hanging - a simple beam extending beyond its support on one end.
4. Double overhanging - a simple beam with both ends extending beyond its supports on both ends.
5. Continuous - a beam extending over more than two supports.
6. Cantilever - a projecting beam fixed only at one end.
7. Trussed - a beam strengthened by adding a cable or rod to form a truss.

2.3 Different Components of Concrete Structure of a Building

Bangladesh is a developing country in the world. Many industrial, commercial, and residential building are to be made in further to develop these all sector very soon. But in most recent, several buildings did not survive because of under strength of the building and counted for a large death toll. Therefore, it is very important to design the individual elements strictly considering all possible loads that suggested by design codes.

2.3.1 Beam

Beams can be described as members that are mainly subjected to flexure and it is essential to focus on the analysis of bending moment, shear, and deflection. When the bending moment acts on the beam, bending strain is produced. The resisting moment is developed by internal stresses. Under positive moment, compressive strains are produced in the top of beam and tensile strains in the bottom. Concrete is a poor material for tensile strength and it is not suitable for flexure member by itself. The tension side of the beam would fail before compression side failure when beam is subjected a bending moment without the reinforcement. For this reason, steel reinforcement is placed on the tension side. The steel reinforcement resists all tensile bending stress because tensile strength of concrete is zero when cracks develop.

2.3.2 Column

Columns are vertical compression members of a structural frame intended to support the load-carrying beams. They transmit loads from the upper floors to the lower levels and then to the soil through the foundations. Since columns are compression elements failure of one column in a critical location can cause the progressive collapse of the adjoining floors and the ultimate total collapse of the entire structure.

As in the case of beams the strength of columns is evaluated on the basis of the following principles:

- 1) A linear strain distribution exists across the thickness of the column.
- 2) There is no slippage between the concrete and the steel (i.e. the strain in steel and in the adjoining concrete is the same)
- 3) The maximum allowable concrete strain at failure for the purpose strength calculations = 0.003 in/in and the tensile resistance of the concrete is negligible and is disregarded in computations.

2.3.3 Slab

The slab provides a horizontal surface and is usually supported by columns, beams or walls. Based on loads transfer to the supporting beam, there are two types:

- i) One-way slabs and
- ii) Two-way slabs.

One-way slab:

If the ratio of length, L to the width, S of one slab panel is larger than about 2, most of the load is carried in short direction to the supporting beams and one-way action is obtained in effect, whether support is provided on long sides or on both sides. Main reinforcement, which will carry total bending moment due to loads on it, is provided perpendicular to the beams, i.e. in short direction only.

Two-way slabs:

If the ratio of length, L to the width, S of one slab panel is equal or less than about 2, the load is carried in both short and long direction to the supporting beams and two-way action is obtained in effect. Support should be provided on both sides. Main reinforcement, which will carry total bending moment due to loads on it, is provided both in long and short directions.

2.3.4 Foundation***Raft or Mat foundation:***

Raft or Mat foundation is a combined footing that covers the entire area beneath a structure and supports all walls and columns. This raft or mat normally rests directly on soil or rock, but can also be supported on piles as well. Raft foundation is generally suggested in the following situations:

- 1) Whenever building loads are so heavy or the allowable pressure on soil so small that individual footing would cover more than floor area.
- 2) Buildings where basements are to be provided or pits located below ground water table.
- 3) Whenever soil contains compressible lenses or the soil is sufficiently erratic and it is difficult to define and assess the extent of each of the weak pockets or cavities and, thus, estimate the overall and differential settlement.
- 4) When structures and equipment to be supported are very sensitive to differential settlement.
- 5) Where structures naturally lend themselves for the use of raft foundation such as silos, chimneys, water towers, etc.
- 6) Floating foundation cases wherein soil is having very poor bearing capacity and the weight of the super-structure is proposed to be balanced by the weight of the soil removed.
- 7) Buildings where individual foundation, if provided, will be subjected to large widely varying bending moments which may result in differential rotation and differential
- 8) Settlement of individual footings causing distress in the building. Let us now examine each of the above situations in greater detail.

In case of soil having low bearing pressure, use of raft foundation gives two fold advantages Ultimate bearing capacity increases with increasing width of the foundation bringing deeper soil layers in the effective zone.

2.3.5 Stair case

Stair cases are provided for connecting successive floors. It is porpoise with flights of steps with intermediate landing which provides rest to the user and support in the flight. A passage is provided at the start of staircase then for the vertical rise a flight is provided with rise and tread. Rise provided in the step is normally 6 inch which conforms to the comfort of the user. Tread provided is 9.5 inch which can be more if the number of users is more depending on the type of building. The width of the stair can be between 3.5 ft to 5 ft depending of the use. Generally public building should be provided with larger width

Going is the horizontal projection of the include flight between the first and the last riser. A flight is generally consisting of two landings with going in between of 10 to 12 steps.

Staircases can be designed in many forms as per the requirement of the user and the facility and space available in the construction. Design procedure of few types is discussed in this chapter.

Stair can be of varying geometrical shapes and structural behavior. Some of the most common types of staircases are shown is subsequent discussion.

- I. Dog legged stair case
- II. Open well stair case
- III. Tread riser stair case
- IV. Cantilever stair case

2.3.6 Water Tank

As per Greek philosopher Thales, “Water is the source of every creation.” In day to day life one cannot live without water. Therefore, water needs to be stored for daily use. Overhead water tank and underground water reservoir is the most effective storing facilities used for domestic or even industrial purpose.

Depending upon the location of the tank the tanks can be named as overhead, on ground or underground. The tanks can be made in different shapes usually circular or rectangular shapes are mostly used. The tanks can be made of RCC or even of steel. The overhead tanks are usually elevated from the roof top through column. In the other hand the underground tanks are rested on the foundation. Different types of tanks and their design procedure is discussed in subsequent portion in this chapter.

The water tanks in this chapter are designed on the basis of no crack theory. The concrete used are made impervious.

Basis on the location of the tank in a building's tanks can be classified into three categories.

Those are:

- Underground tanks
- Tank resting on grounds
- Overhead tanks

In most cases the underground and on ground tanks are circular or rectangular but shape of the overhead tanks are influenced by the aesthetical view of the surroundings and as well as the design of the construction.

Steel tanks are also used specially in railway yards. Basing on the shape of the tanks can be circular, rectangular, square, polygonal, spherical, and conical. A special type of tank named Intel tank is used for storing large amount of water for the column, which acts as stages, supports area. This column can be braced for increasing strength as well as to improve the aesthetic views.

2.4 Reinforcing Steel

The reinforcing materials are selected from nearly an infinite number of possible choices.

Reinforcing bars

The most common type of reinforcing steel is in the form of round bars, often called rebar, available in a large range of diameters from about $\frac{3}{8}$ to $1\frac{3}{8}$ inch for ordinary applications and in two heavy bar sizes of about $1\frac{3}{4}$ and $2\frac{3}{4}$ inch. These bars are furnished with surface deformations for the purpose of increasing resistance to slip between steel and concrete. Minimum requirements for these deformations (spacing,

projection, etc.) have been developed in experimental research. There are different bar producers in the world, all of them satisfies these requirements.

Grades and strength:

Grade & Strength of Reinforcement is shown table 2.1

Table 2.1: Summary of Minimum ASTM strength Requirements

Product	ASTM Specification	Designation	Minimum yield strength psi (MPa)	Minimum tensile ultimate strength psi (MPa)	
Reinforcement bars	A615	Grade 40	40000 (280)	60000 (420)	
		Grade 60	60000 (420)	90000 (620)	
		Grade 75	75000 (520)	100000 (690)	
	A706	Grade 60	60000 (420) 78000 (540)	80000 (550)	
		A996	Grade 40	40000 (280)	60000 (420)
			Grade 50	50000 (350)	80000 (550)
Grade 60	60000 (420)		90000 (620)		

2.5 Gravity Loads

2.5.1 Dead Load

Such loads are constant in magnitude and fixed in location throughout the lifetime of the structure. This includes the weight of the structure itself, as well as anything non-movable that is permanently attached to the structure. Therefore, dead loads include the gravity loads from floors, beams, ceilings, roofs, pipes (plumbing), ventilation ducts, and windows. It does not include furniture because they are movable.

2.5.2 Live Load

Such loads are different from dead load because they vary in magnitude and location. Examples include people, furniture, cars and stored goods. Live loads cannot be accurately estimated because the load is variable and unknown. For instance, before the building is built and the tenants have moved in, this doesn't know how many people and how much or what kind of furniture will be on any

floor of the structure. Minimum distributed and concentrated loads that should be considered in design as live load.

All dead and live loads are considered as uniformly distributed loads acting on the structures.

Total uniformly distributed loads = Total dead loads + Total live load.

2.6 Lateral Loads

2.6.1 Wind Load

The minimum design wind load on buildings and components shall be determined based on the velocity of the wind, the shape and size of the building and the terrain exposure condition of the site. The design wind load shall include the effect of the sustained wind velocity component and the fluctuating component due to gusts. For slender buildings, the design wind load shall also include additional loading effects due to wind induced vibration of the building.

Terrain Exposure:

A terrain exposure category that adequately reflects the surface roughness characteristics of the ground shall be determined for the building site, taking into account the variations in ground roughness arising from existing natural topography, vegetation and man made constructions. The exposure category is divided into three types-

1. Exposure A: Urban and sub-urban areas, wooded areas, hilly or other terrain covering at least 20 percent of the area with obstructions of 6m or more in height and extending from the site at least 500m or 10times the height of the structure, whichever is greater.
2. Exposure B: Open terrain with scattered obstructions having height generally less than 10 m extending 800m or more from the site in any full quadrant. This category includes air fields, open park lands, and sparsely built-up outskirts of towns, flat open country and grasslands.
3. Exposure C: Flat and unobstructed open terrain, coastal areas and riversides facing large bodies of water, over 1.5 km or more in width, It extends inland from the shoreline 400m or 10times the height of structure, whichever is greater.

Wind Pressure on Building:

Wind is one of the significant forces of nature that must be considered in the design of building. Structural load applied by high winds is readily appreciated, even if the method of determining them is not so easily understood. Other effect that can be caused even by moderate breezes overlooked, however, because very often there is no obvious link between wind and the behavior of a building.

Rain leakage around flashings and through joints in curtain walls may be due to a pressure gradient across the wall and functioning of ventilating and heating systems may be affected by pressure distributions where ducts and opening are located.

Thus, it is only the structural engineer who must consider wind action but the architect and mechanical engineer as well. The latter are often consider with the maximum pressures that can reasonably be expected to occur during the useful life of the structure.

Conversion from Wind Speed to Wind Pressure:

Wind pressures exerted on a structure depend on the speed of the wind as well as the interaction between the airflow and the structure. The wind speed to be used in computing the design pressure depends on the particular component of the building being designed. For structure purposes the maximum value is required and will vary with the geographical location. Meteorological records of wind speed are analyzed to yield the most probable maximum that will be equaled or exceeded, on the average, once during a given period of a time comparable to the life of a structure.

Sustained Wind Pressure

$$Q_z = C_c \times C_i \times C_z \times V_b^2$$

where,

Q_z = Sustained wind pressure at height z, kN/m²

C_c = Velocity- to- pressure conversion

C_i = Structural importance coefficient

C_z = Combined height & exposure coefficient

V_b = Basic wind speed in Km/hr

Design Wind Pressure:

$$P_z = C_g \times C_p \times Q_z$$

where,

P_z = design wind pressure at height z , kN/m²

C_g = gust coefficient

C_p = pressure coefficient for structure or component

Q_z = sustained wind pressure

Pressure Coefficient:

Pressure coefficient used in practice has usually been obtained experimentally by testing models of different type's f structures in wind tunnels. Commonly used coefficient refers to the average pressure or suction over a surface. Tangential forces are considered insignificant, so that the force referred to at right angles to the surfaces in question.

Variables Affecting Pressure Distributions:***Building Shape:***

Pressure on certain parts of a structure is rather sensitive to changes in the shape of the building. The suction on the windward roof slope, for instance, very considerably with the slope of the roof, the ratio of height to width, and the ratio of width to length of the building. Suctions on the leeward wall, on the other hand, are not greatly affected by such variables. Sometimes shape details have an unexpectedly large effect on the wind pressure distribution. Parapet walls, large chimneys, silos and spires may have a considerable influence and often the only way to assess such effects is to test a scale model in a wind tunnel.

Openings:

The size and location of opening such as windows and doors determine the internal pressure that must be considered in the calculation of net forces on walls and roofs. Internal pressures tend to take on the values appropriate to the exterior of the wall in which the opening predominate. If they are small and uniformly distributed, values of ± 2 are recommended, the more unfavorable of the two to be considered in each case.

Wind direction:

The orientation of a building to the wind has a marked effect on pressure distribution, particularly on suction maximum, which occur over a small area near the leading edges on roofs.

Increase of Wind Speed with Height:

Since the wind speed and consequently the velocity pressure increase with height above the ground, a height is applied to the basic pressure in the design of building.

Shielding:

Other buildings, trees and similar large objects in the immediate vicinity have a bearing on pressure distribution. The shielding provided is usually difficult to estimate and model tests provide the most convenient means of determining design values. The assignment of reductions for shielding is complicated by the fact conditions could change during the life of the structure. Shielding does not always have a beneficial effect and in some cases suction coefficient should be increased because of the proximity of a neighboring building.

Wind Pressures on Various Part of Building:***Roofs:***

The roof is usually the critical area in the wind design of low building, particularly residential structures. Where it is made up of light-weight components particular attention must be paid to anchorage details because of the suction condition prevailing over most, if not all, of it. A good example of such precautions is the time-honored custom of weighting roofs in alpine areas with large stones.

Critical angle, Windward slope:

For every slope roof there is a certain slope angle at which the suction coefficients over the windward slope reaches a numerical maximum.

Steep roofs:

As the roof slope increases beyond the critical angle the average pressure coefficient decreases numerically to zero; it then increases in a positive direction, indicating pressure, to a maximum of +0.8 or so for a slope angle of 90 degrees

Leeward slope:

The effect of slope and building dimension ratios much less pronounced on suction on the leeward slope and for general purposes could probably be disregarded.

Local suctions:

Local suctions are more serious for wind at an angle (usually about 45 degree) to the side of the building.

Walls:

For tall, slender structure the design of the walls and the frame, with regard to overturning moment, are likely to be critical. The trend toward high-rise buildings and curtain wall construction may lead to greater problems in limiting sway and specifying the strength of fastening for the wall panels.

Limitation:

The following cases will be beyond the scope of these provisions:

- Forces due to cross-wind response of the buildings and structures
- Forces, such as torsion etc. generated due to unusual or unsymmetrical geometry of the building and
- Forces generated due to special types of winds, such as tornadoes.

2.7 Earthquake Load

Minimum design earthquake forces for buildings, structures or components of buildings or structures, can be calculated either by the Equivalent static force method or by the Dynamic response method. We will calculate earthquake load by equivalent static force method

2.7.1 Seismic Zoning Map

The seismic zoning map of Bangladesh is provided by BNBC. Based on the severity of the probable intensity of seismic ground motion and damages, Bangladesh has been divided into three seismic zones. This are-

1. Zone 1
2. Zone 2
3. Zone 3

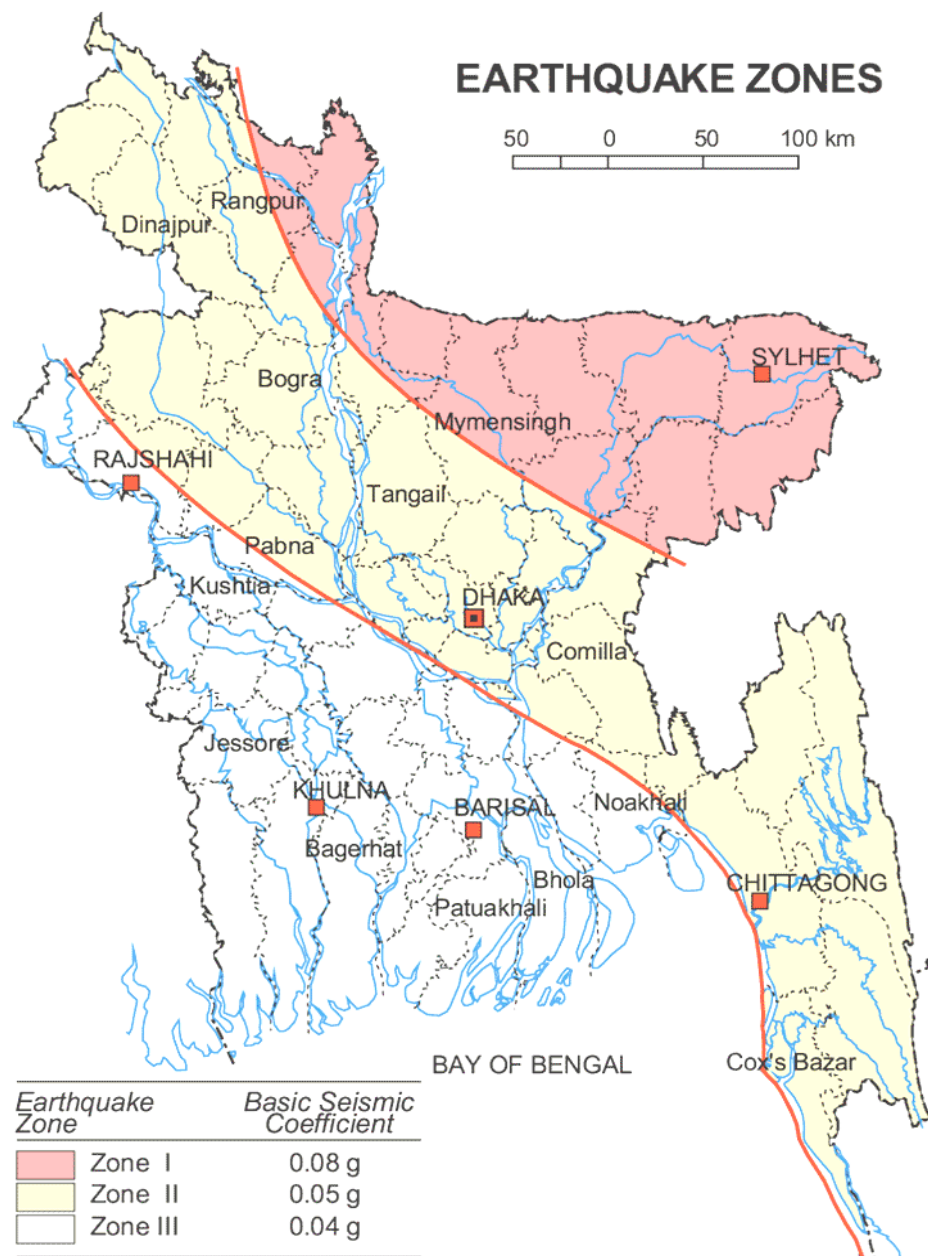

Figure 2.2: Division in earthquake zones of Bangladesh

2.8 Effects of Earthquakes on Reinforced Concrete Buildings

These lateral inertia forces are transferred by the floor slab to the walls or columns, to the foundations, and finally to the soil system underneath. This sometimes leads to settlement of foundation due to soil liquefaction.

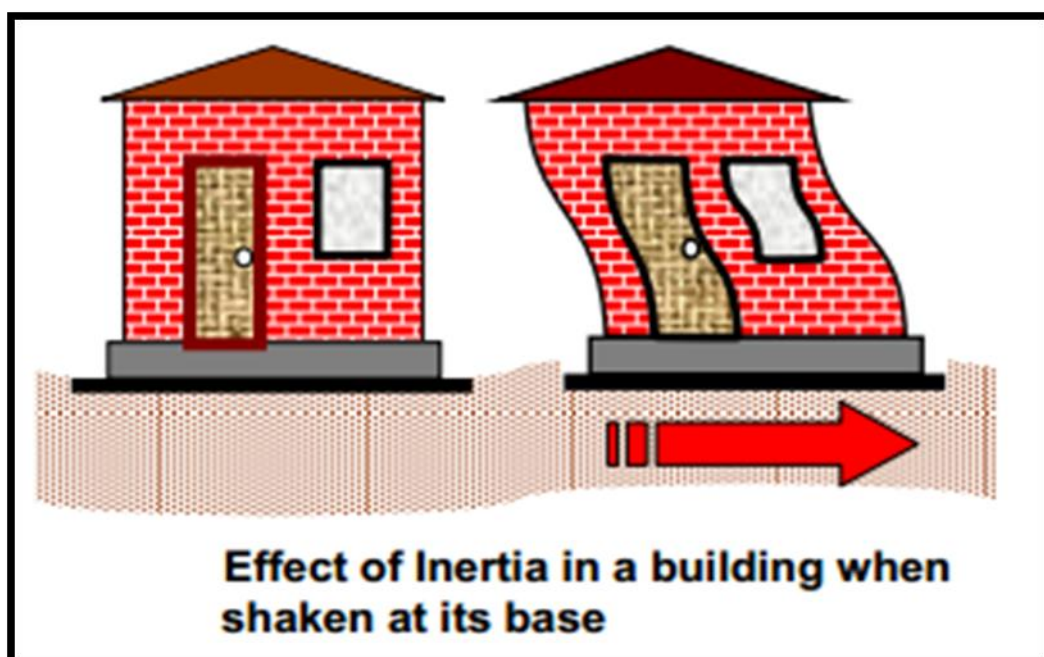
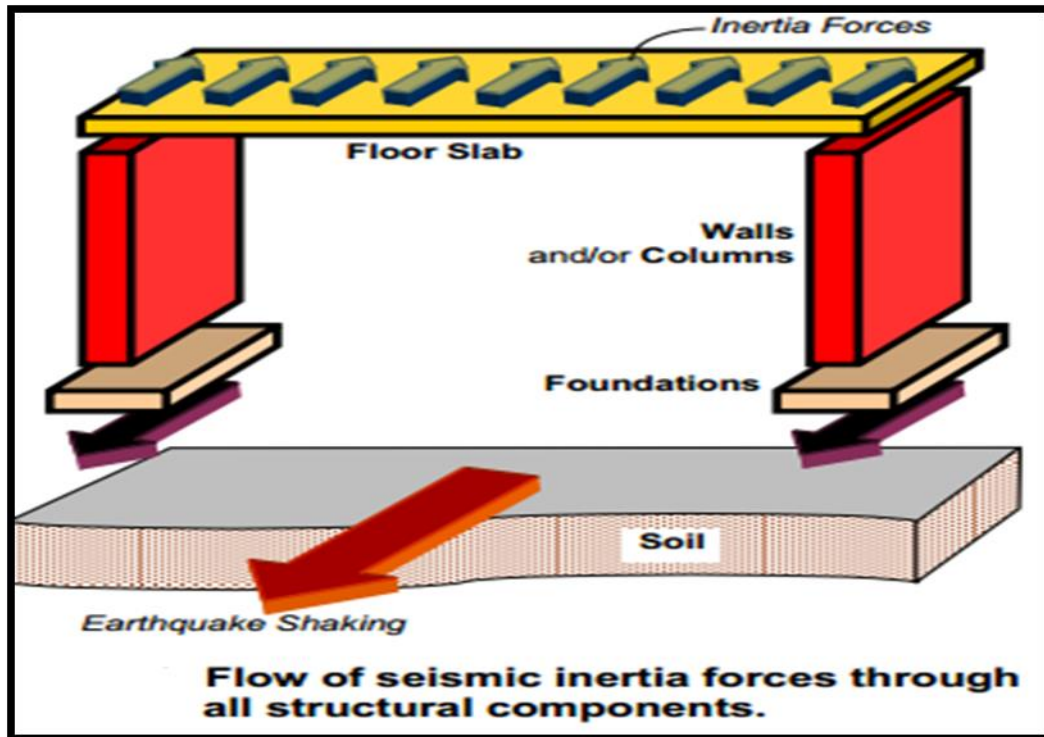

Figure 2.3: Earthquake effect in a building

2.8.1 Selection of Lateral Force Method

Seismic lateral forces on primary framing systems shall be determined by using either the equivalent static force method or the Dynamic response method with the restriction given below:

- a) The equivalent static force method
 1. All structure, regular or irregular, in seismic zone 1 and in structure importance category IV in seismic zone 2, except case b4 below.
 2. Regular structures less than 75 m in height with lateral force resistance provided by structural systems listed in BNBC except case 4 below.
 3. Irregular structures not more than 20 m in height.
 4. A tower like building or structure having a flexible upper portion supported on a rigid lower portion where:
 - Both portions of the structure considered separately can be classified as regular structures,
 - The average story stiffness of the lower portion is at least in times the average story stiffness of the upper portion
 - The period of the entire structure is not greater than 1.1 times the period of the upper portion considered as a separate structure fixed at the base.
- b) The Dynamic response method shall be used for structures of the following types-
 1. Structures 75 m or more in height except as permitted by case a (1)
 2. Structures having stiffness, weight or geometric vertical irregularity of type 1, 2 & 3 is defined in the BNBC table or structure not described.
 3. Structure over 20 m in height in seismic zone 3 not having the same structural system throughout their height except as permitted by BNBC.
 4. Structures, regular or irregular, located on soil profile type S_4 as described, which have a period greater than 1 second. The analysis shall include the effect of the soils at the site.

2.8.2 Seismic Dead Load

Seismic dead load, W is the total dead load of a building or a structure, including permanent partitions and applicable portions of other loads listed below:

- 1) In storage and warehouse occupancies, a minimum of 26 percent of the floor live load shall be applicable.
- 2) Where an allowance for partition load is included in the floor design in accordance with BNBC all such loads but not less than 0.6 (kN/m²) shall be applicable.
- 3) Total weight of permanent shall be included.

2.8.3 Equivalent Static Force Method

Design base shear:

$$V = (ZIC/R) \times W$$

where, Z = Seismic zone coefficient

I = Structure importance coefficient

R = Response modification coefficient for structural systems

W = Total seismic dead load

C = Numerical coefficient given by the relation-

$$C = (1.25S)/T^{2/3}$$

where, S = Site coefficient for soil characteristics

T = Fundamental period of vibration in seconds

$$T = C_t (h_n)^{3/4}$$

Where $C_t = 0.083$ for steel moment resisting frames

= 0.073 for reinforced concrete moment resisting frames and eccentric

= 0.049 for all other structural systems.

h_n = Height in meters above the base to level

➤ Vertical Distribution of Lateral Force

In the absence of a more rigorous procedure, the total lateral force, which is the base shear V , shall be distributed along the height of the structure in accordance with the following equation:

$$v = F_t + \sum F_i$$

where,

F_i = Lateral force applied at story level I

F_t = Concentrated lateral force considered at the top of the building in addition to the force F_n .

where,

$$F_t = 0.07TV \leq 0.25V \quad \text{when } T > 0.7 \text{ second}$$

$$F_t = 0.0 \quad \text{when } T \leq 0.7 \text{ second}$$

The remaining portion of the base shear ($V - F_t$), shall be distributed over the height of the building, including level $-n$, according to the relation:

$$F_i = ((v - F_t) \times W_i \times h_i) / \sum W_i \times h_i$$

2.9 Analysis and Design Basis

This thesis is prepared properly based on Bangladesh National Building Code and ACI codes. Every part of this thesis is properly maintained the recommendation of this code.

Here some features are described below-

Bangladesh country paper for WCDR 7

Does your country have building codes of practice and standards in place?

Which takes into account seismic risk?

The National Building Code was formulated and published in 1993. Bangladesh does not have any separate code for the design or construction of earthquake resistant structures.

However, a new seismic zoning map and detailed seismic design provisions were incorporated into the National Building Code in 1993 that replaces the code prepared in 1979. The Bangladesh Earthquake Society has recently published a Bengali translation of the Guidelines for Earthquake Engineering 3. Reinforcement of the standards presented in the National Building Code requires close monitoring by concerned agencies. The shortage of trained staff to monitor new construction impedes the effectiveness of the building standards.

2.9.1 Analysis Software

There is much finite element software for analyzing structure. ETABS is one of them. Every analysis in this thesis is done by using ETABS 9.7.1. In the following paragraph we will discuss some of its features-

Introduction:

ETABS is a sophisticated, yet easy to use, special purpose analysis and design program developed specifically for building systems. ETABS 9.7.1 features an intuitive and powerful graphical interface coupled with unmatched modeling, analytical, and design structure, ETABS can also handle the largest and most complex building models,

including a wide range of nonlinear behaviors, making it the tool of choice for structural engineers in the building industry.

History and Advantages of ETABS: Integrated Analysis, Design and Drafting of Building Systems

The innovative and revolutionary new ETABS is the ultimate integrated software package for the structural analysis and design of buildings. Incorporating 40 years of continuous research and development, this latest ETABS offers unmatched 3D object-based modeling and visualization tools, blazingly fast linear and nonlinear analytical power, sophisticated and comprehensive design capabilities for a wide-range of materials, and insightful graphic displays, reports, and schematic drawings that allow users to quickly and easily decipher and understand analysis and design results.

From the start of design conception through the production of schematic drawings, ETABS integrates every aspect of the engineering design process. Creation of models has never been easier – intuitive drawing commands allow for the rapid generation of floor and elevation framing. CAD drawings can be converted directly into ETABS models or used as templates onto which ETABS objects may be overlaid. The state-of-the-art SAP Fire 64-bit solver allows extremely large and complex models to be rapidly analyzed, and supports nonlinear modeling techniques such as construction sequencing and time effects (e.g., creep and shrinkage). Design of steel and concrete frames (with automated optimization), composite beams, composite columns, steel joists, and concrete and masonry shear walls is included, as is the capacity check for steel connections and base plates. Models may be realistically rendered, and all results can be shown directly on the structure. Comprehensive and customizable reports are available for all analysis and design output, and schematic construction drawings of framing plans, schedules, details, and cross-sections may be generated for concrete and steel structures.

ETABS provides an unequalled suite of tools for structural engineers designing buildings, whether they are working on one-story industrial structures or the tallest commercial high-rises. Immensely capable yet easy-to-use has been the hallmark of ETABS since its introduction decades ago, and this latest release continues that tradition by providing engineers with the technologically-advanced, yet intuitive, software they require to be their most productive.

Finite Element Modeling of Objects:

Object based graphical modeling with unique finite element formulations and auto-meshing enable ETABS to accurately model floors and walls using finite elements as an alternative to rigid diaphragms. This provides important advantages: Accurate, automatic distribution of forces/ moments through slabs and walls for design, and the ability to check and design for axial force in beams – none of which is possible when using rigid diaphragms. No more error prone assumptions regarding uniform load distribution through floors, walls, and framing. Automatic calculation of floor and wall self-weight, mass and stiffness based on section properties. Auto-meshing provides automatic transfer of gravity and lateral floor and wall loads, even with openings, overhangs, or variable thickness. One integrated system – no more time-consuming error prone transfer of results and models between different modules or programs for gravity and lateral load analysis and design. Concrete, composite beam, joists, steel design, drift all in one package.

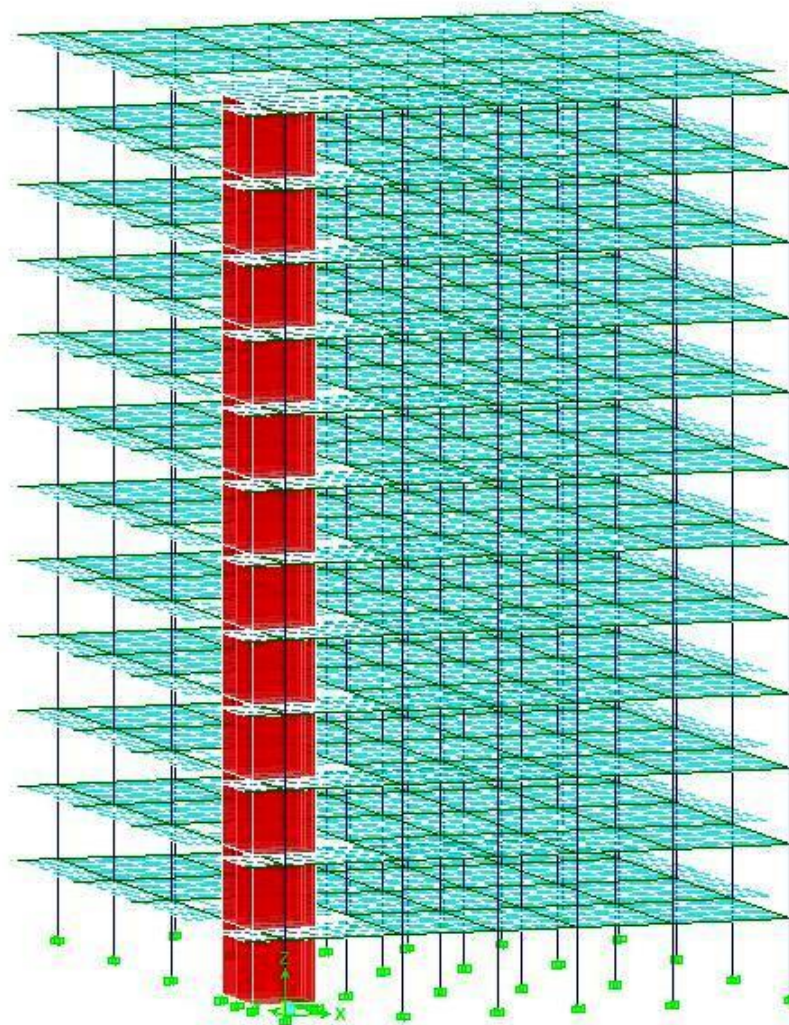

Figure 2.4: Mesh of building model

Shear walls – ETABS integrates stresses into one area based on user specified pier or spandrel label. For example, if 8 wall finite elements have been assigned the same pier label, forces and moments will be integrated such that all 8 elements are treated as one (1) pier/column for reinforcement design, and in reporting of shears and moments. Among other advantages, this enables ETABS to treat multiple wall panels as one 3D section if desired. Torsion is automatically converted into shear.

Composite beam design - It can be the options for camber, partial composite connection, user defined or uniform shear connector layout, cover plates, shared or unshared design subjected to vibration or pattern loadings.

Steel member sizes can be optimized based on strength per design code and/or drift requirements with user defined auto select lists of sections. Compare ETABS optimization to manual trial and error, analyzing one section per member at a time.

Line constraint automatically ‘connects’ course mesh with finer mesh for accurate transfer of loads – this is often the case when walls come into floor elements or into beams where common joints are not shared. ETABS may save the analysis time and prevents errors in load transfer between objects.

True physical member length – When designing and analyzing continuous members which are intersected by other members, ETABS does not break up the continuous member into multiple segments for reporting of results or editing. Compare this with having to manage multiple segments and multiple moment diagrams which represent just one continuous member.

For slab and foundation reinforcement design and punching shear checks, ETABS will automatically transfer forces/moments on slabs for each load case, slab properties and geometry into SAFE design software.

True physical member length – When designing and analyzing continuous members which are intersected by other members, ETABS does not break up the continuous member into multiple segments for reporting of results or editing. Compare this with having to manage multiple segments and multiple moment diagrams which represent just one continuous member.

For slab and foundation reinforcement design and punching shear checks, ETABS will automatically transfer forces/moments on slabs for each load case, slab properties and geometry into SAFE design software.

Similar stories feature – When drawing or editing the model on one story, changes and additions can automatically ripple down to similar stories. ETABS provides output

options you can really use – Instead of typical output reports with non-descript nodal deflections, forces & moments, etc., ETABS organizes results to provide: inter-story drift, center of mass and rigidity of each level, story by story report of shears and overturning moments, column and beam reactions reported separately on a story by story basis. Results can be reviewed interactively by clicking on members/joints, printed reports, export to Excel or Access database, and generation of usable DXF drawings and CIS/2 files.

Automatic generation of lateral loads – 9 built-in U.S. and international design codes for auto wind loading with windward and leeward assignment options. Steel design options based on lateral drift. Automated code design beyond the basics – Automatic load combinations per design code, automatic determination of unsupported lengths, much more.

Advanced analysis – Nonlinear pushover analysis using large deflection with plastic hinge stress/strain curves. Nonlinear staged construction analysis, base isolators, gaps/hooks, structural pounding analysis, linear and nonlinear dampers, P-Delta analysis, rigid link constraints to connect meshes which do not share common joints, panel zone springs at beam/column intersections including effects of doubler plates. Response spectrum as well as linear and nonlinear dynamic analyses, consideration of vertical motion components as well as lateral.

Remarks

Bangladesh is a developing country. Its economy is raised day by day but most of its economic activities are centered to the capital Dhaka. People need more place to dwell. But the land is not sufficient to meet their demand. With the increase of population, the land is divided into small pieces. To meet the dwelling needs people, build high rise hospital building. For the decentralization of Dhaka, we design twelve storied hospital building also at Dhaka.

The parking problem is a great problem in our country especially in Dhaka city on such a small piece of land. This thesis is based on the previously discussed topics. This thesis may result an effective solution of this problem.

CHAPTER 3

DESCRIPTION OF THE PROPOSED BUILDING

3.1 Introduction

This chapter provides detailed description of the whole structure. The main features can be summarized as below:

- Height of building : 132 ft
- Length of building : 90 ft 2 inch
- Width of building : 109 ft 5 inch
- Total floors : 12 nos. (Including one basement floor)
- Types of floors
 1. One Basement – Car parking
 2. Ground floor to 10th floor – Hospital floor

Modern amenities: High speed sixteen passengers lift, generator facilities for emergency current supply, large car and bike parking at the basement, bigger underground reservoir and water tank for fulfilling huge water supply demand and sewerage tank for waste water management of all users.

Security system: There are automatic fire and security alarming systems in the building. Car safety at basement floor is ensured by the security guards at both entry and exit.

Safety of the St.: Designed as per ACI and BNBC codes and specifications. Capable for resisting 210 km/h wind speed and high Richter scale earthquake affects. 3.5 ksi concrete ($w_c = 150$ pcf) and 60-grade deformed bars are used.

3.2 Description of the Different Floors

3.2.1 Basement Floor

- 5'-6" down from road level and connected with ground floor by stair.
- Used for car parking-capacity of 21 nos. cars or ambulance.
- Total floor area is = 9865.66 ft².
- Total floor height 11'-0".
 - 5' high concrete retaining wall (10" thick & 14" thick).
 - 5' high brick wall (5" thick).
 - 1' ventilation facilities.
- Drivers' waiting room (15'-8"x13'-2")
- Wash room (8'-5"x11'-7")
- Generator Room (16'-3"x13'-2")
- Electric machine Room (14'-9"x13'-2")
- Emergency (24'-8"x22'-8")
- Water tank (19'6" x 40.32')
- Sub Station (27'6" x 62.34")

3.2.2 Ground Floor to Level-10

- 5'-6" high from road level.
- Floor height 11'-0".
- Total floor area is 9865.66 ft².
- Connected with other floors by stair (Ground floor), 16 passenger's elevator (Ground floor to 10th).
- Stair from road level for entrance ground floor.
- Connected with other floors by stair & passenger elevator.

The plan view of the Ground Floor to Level-10 with all facilities is shown in Figures 3.1 and 3.2, respectively.

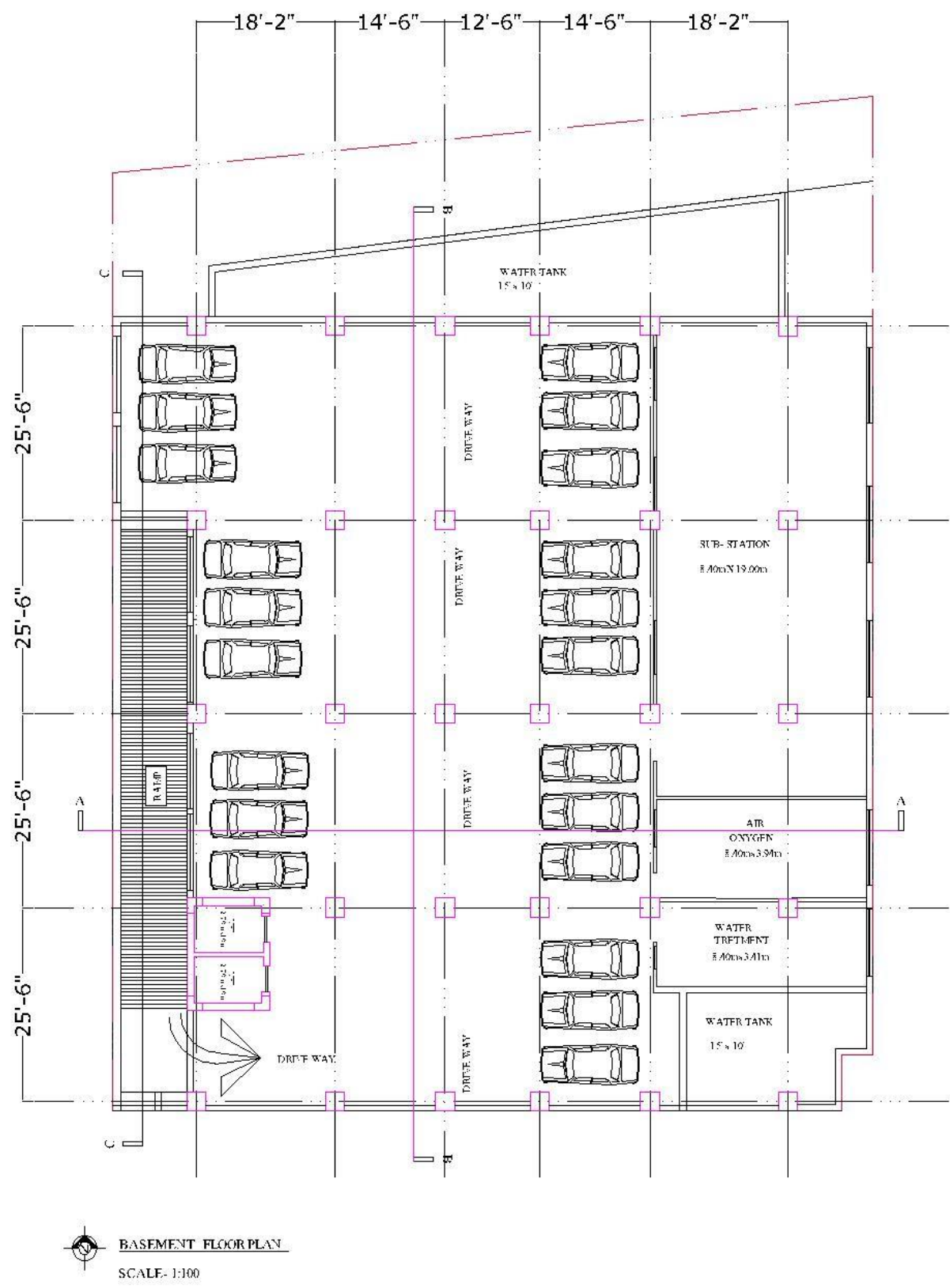

Figure 3.1: Basement Floor Plan

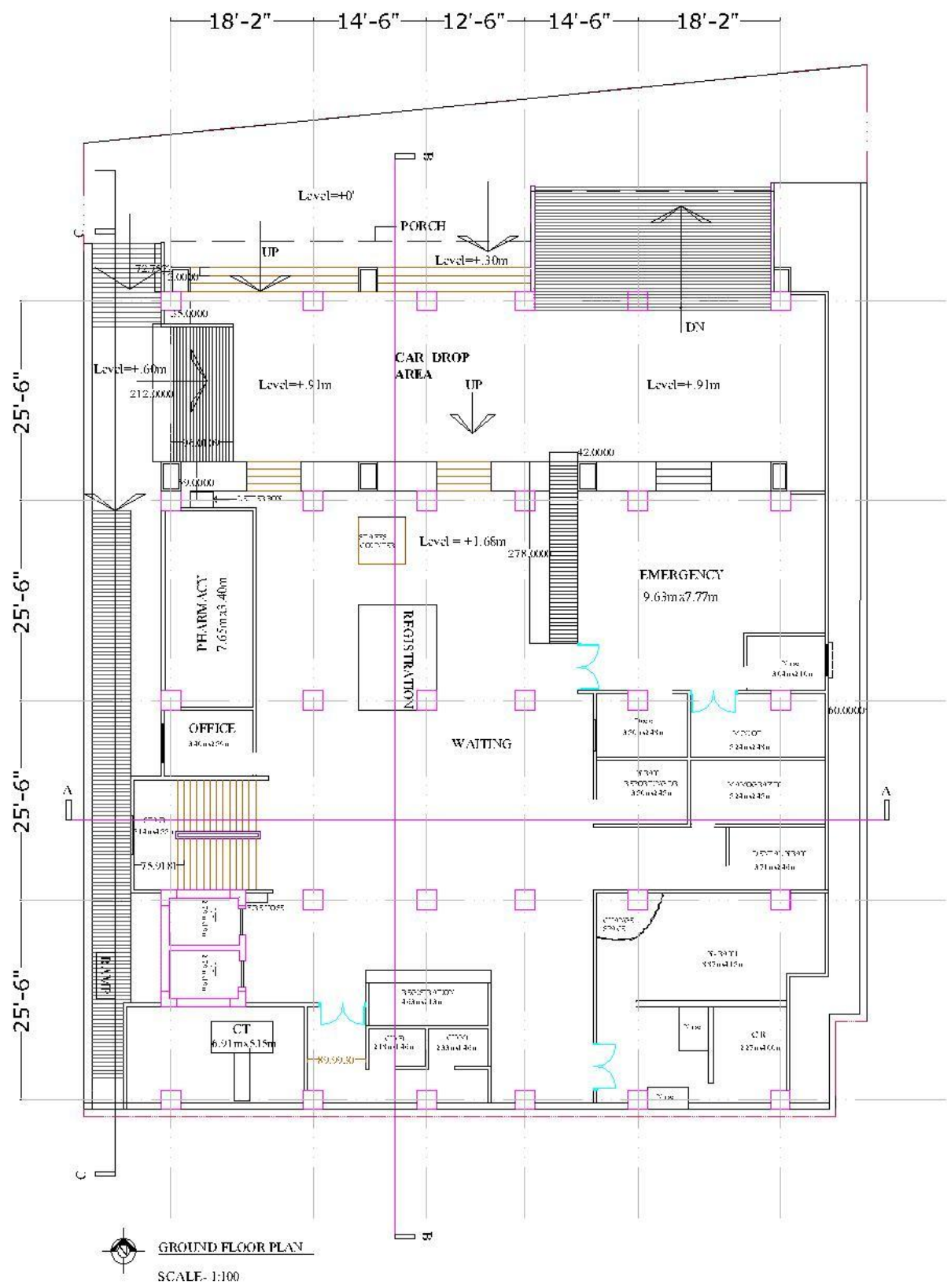

Figure 3.2: Ground floor plan

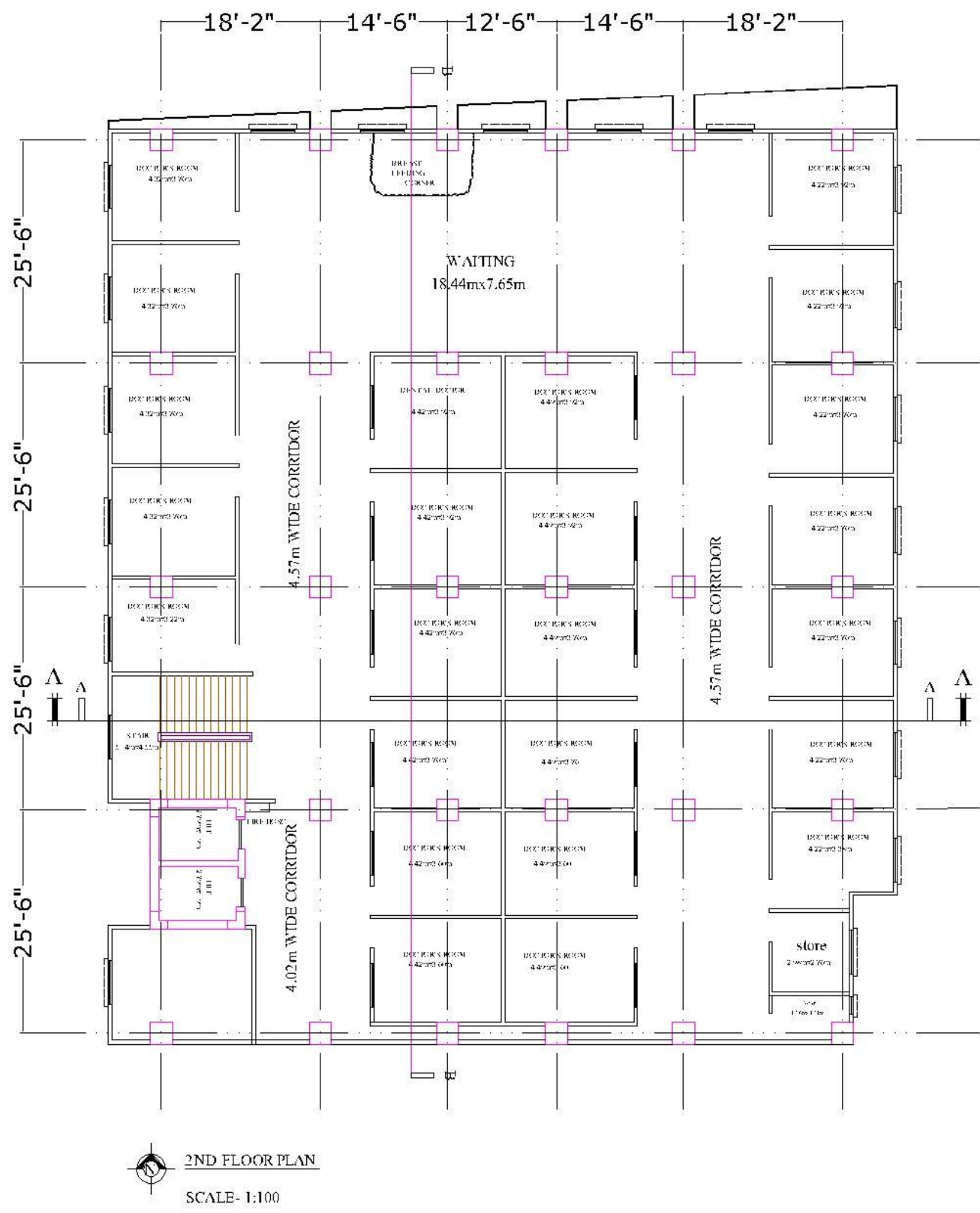

Figure 3.4: 2nd floor plan

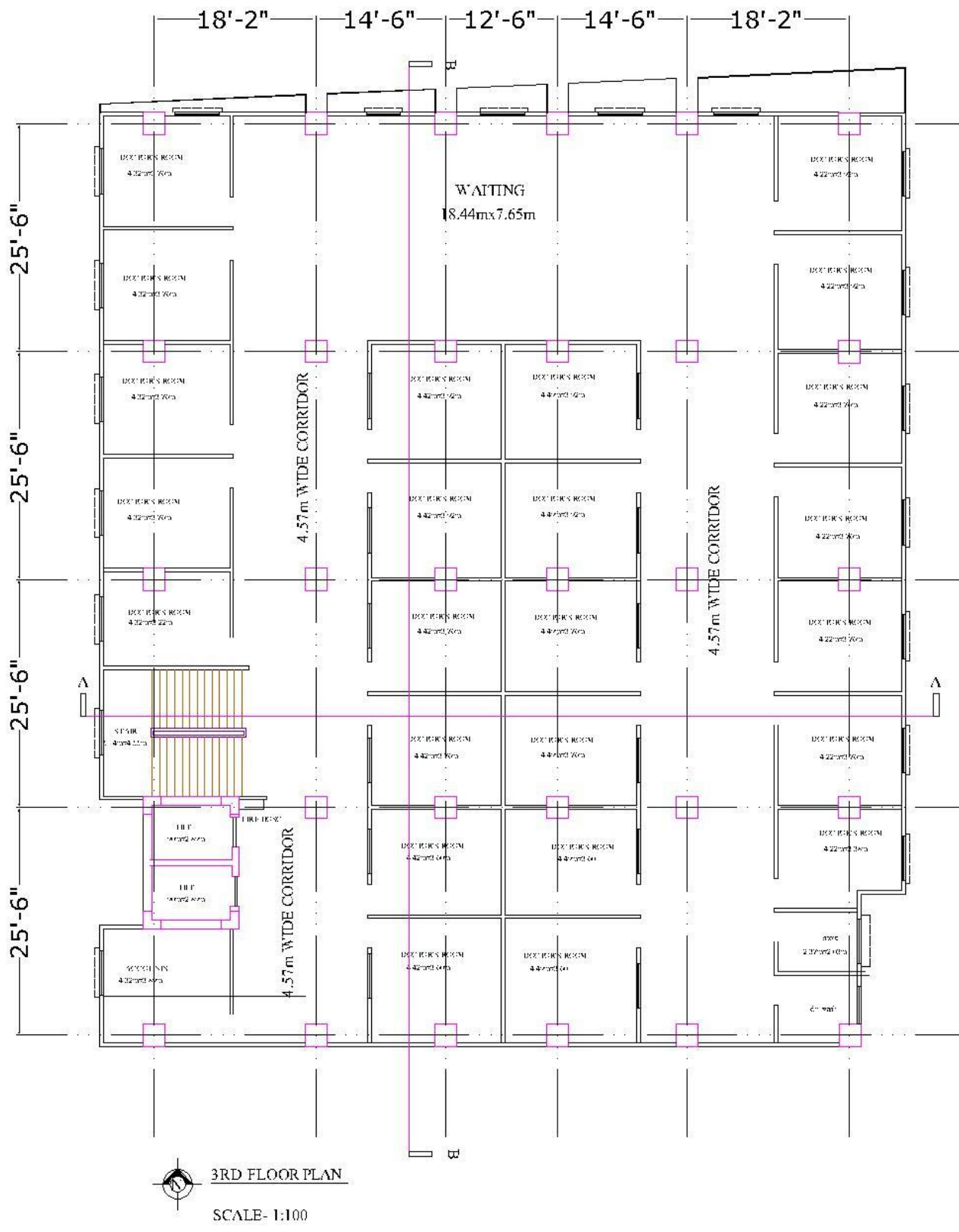
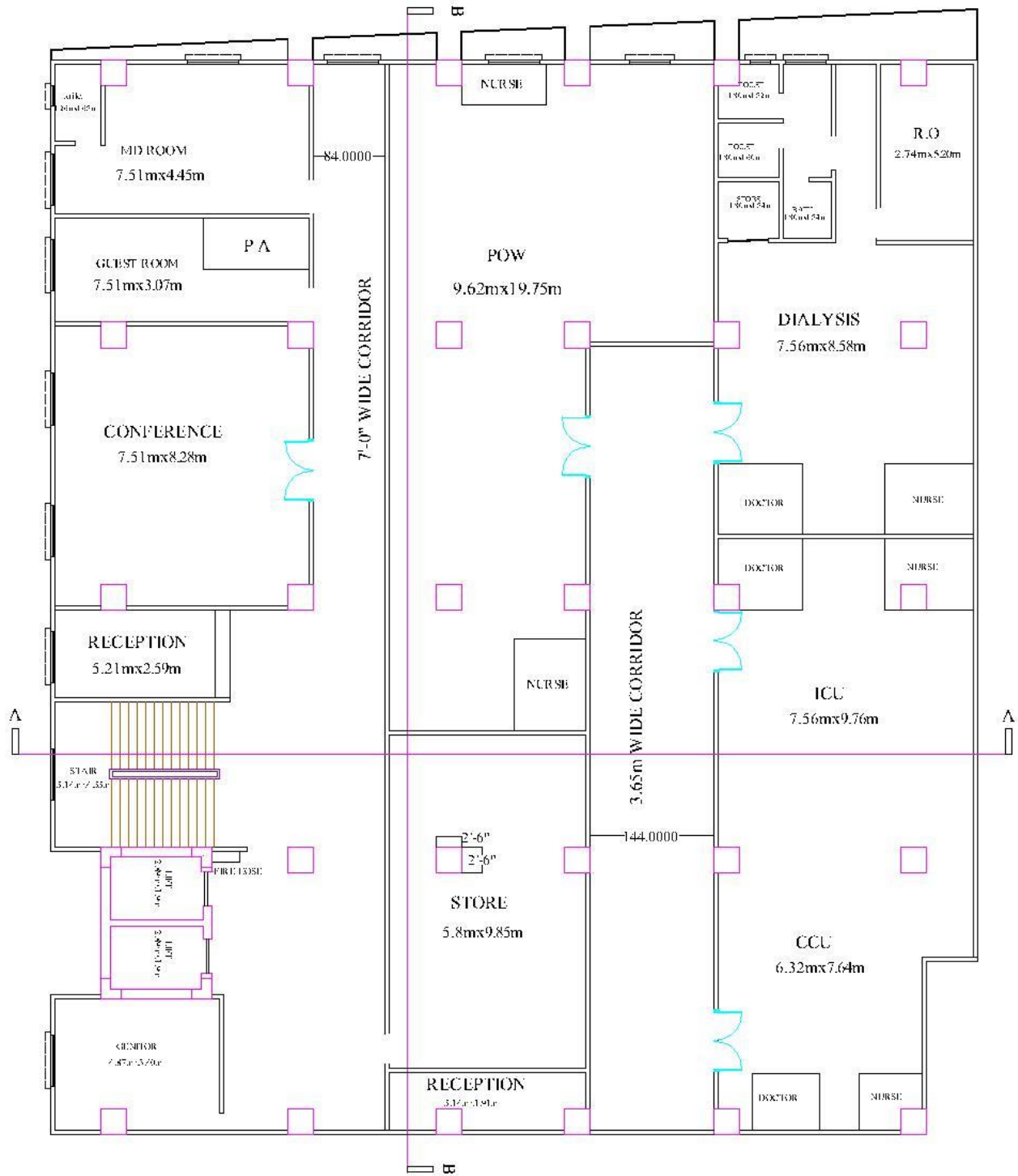

Figure 3.5: 3rd floor plan





4TH FLOOR PLAN
 SCALE- 1:100

Figure 3.6: 4th floor plan



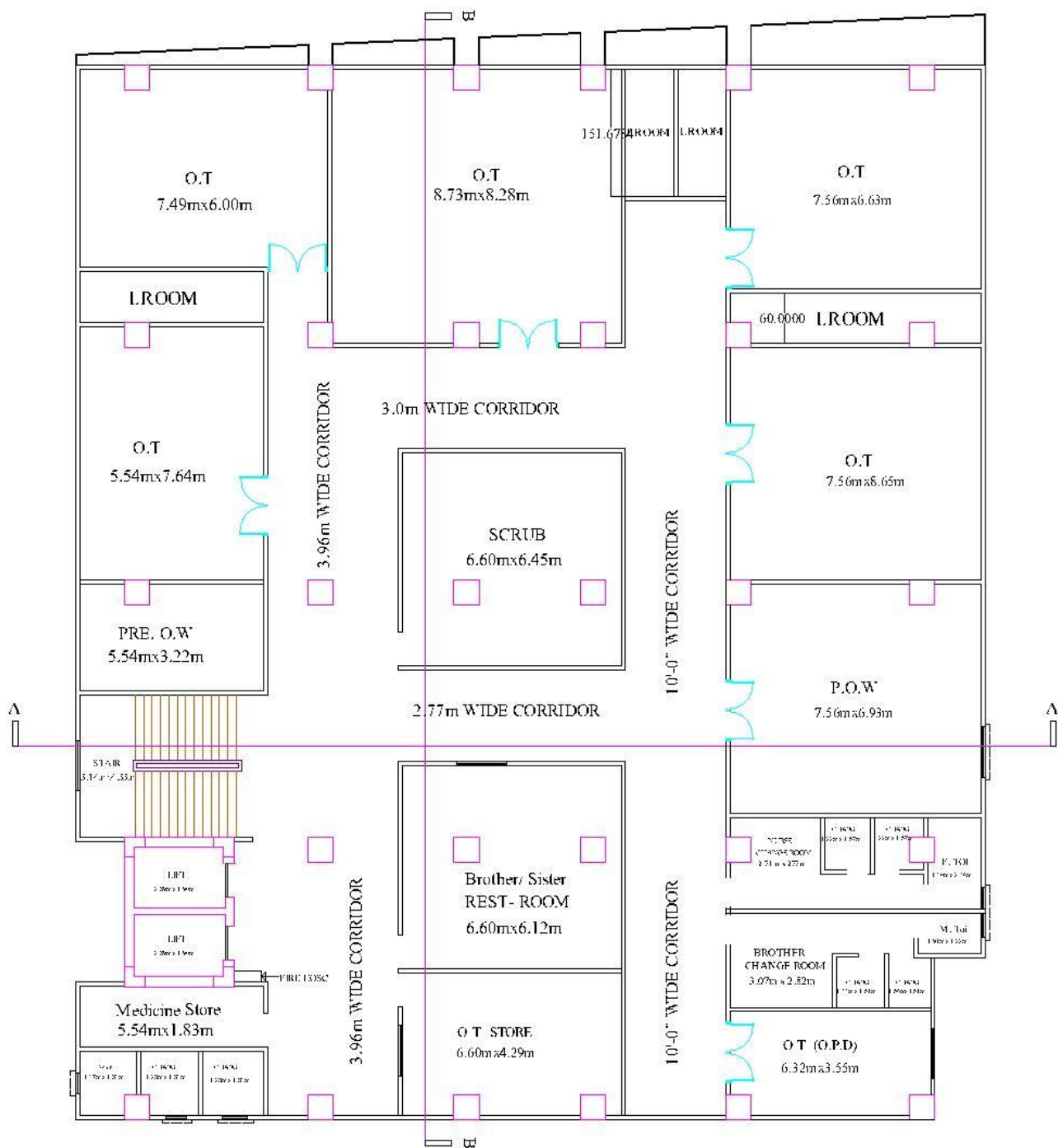

5TH FLOOR PLAN
 SCALE- 1:100

Figure 3.7: 5th floor plan

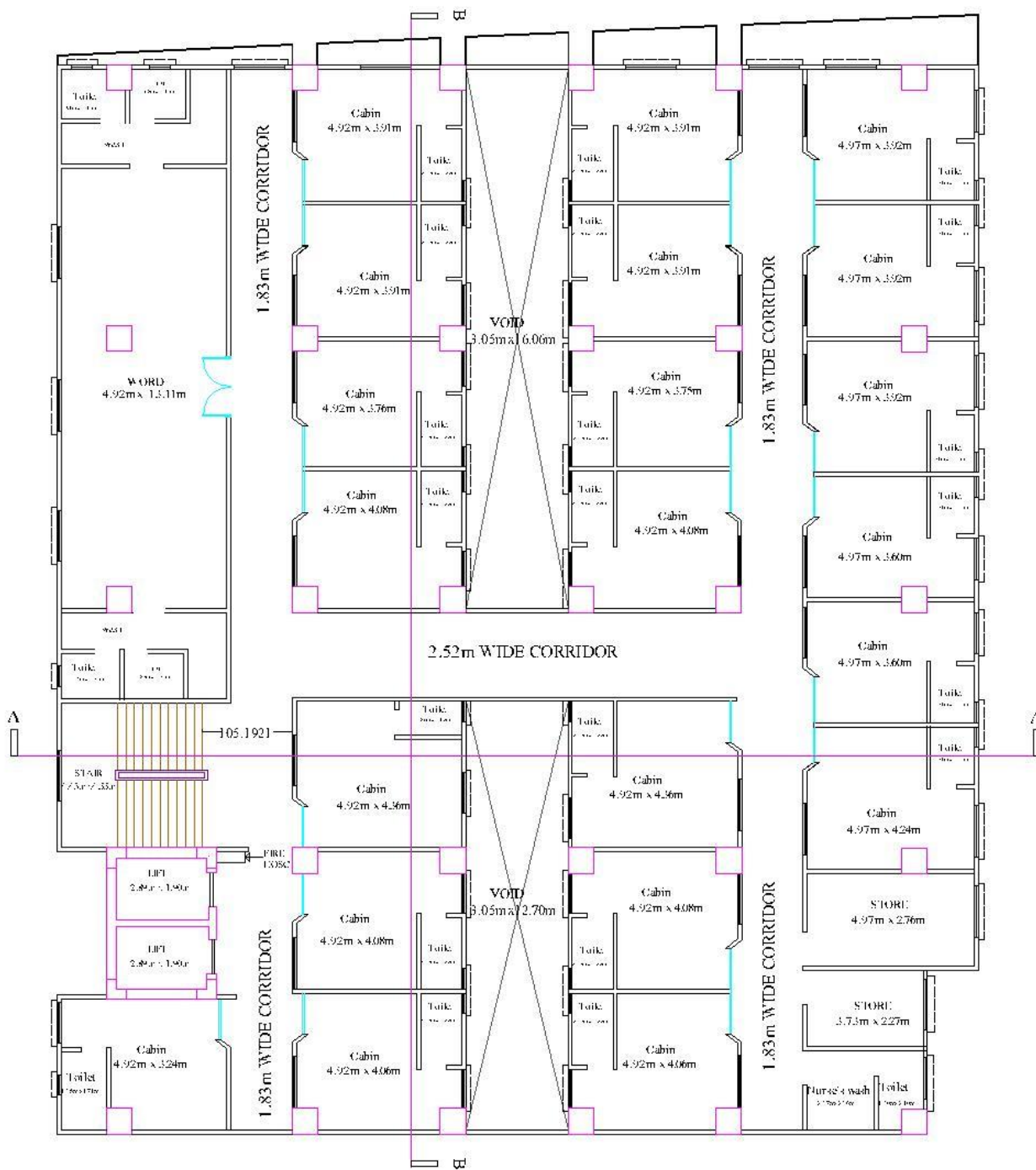

6TH TO 9TH FLOOR PLAN
SCALE- 1:100

Figure 3.8: 6th to 9th floor plan

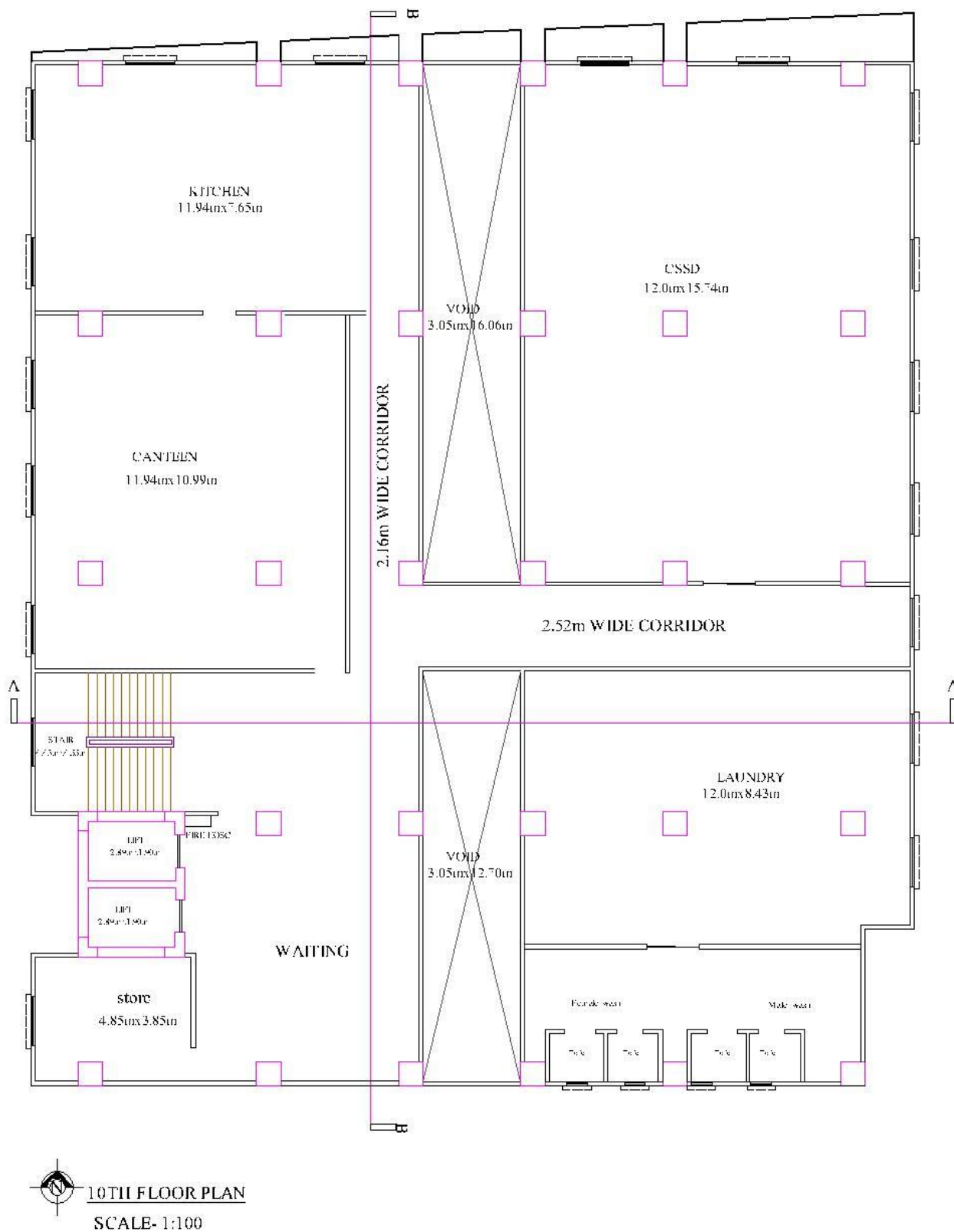

Figure 3.9: 10th floor plan

CHAPTER 4

EARTHQUAKE AND WIND LOADS

4.1 General

The same building frame is analyzed using ETABS software considering lateral loads. The lateral loads for earthquake and wind are calculated manually for the proposed building. The lateral forces are calculated separately for both seismic zones following BNBC (1993).

4.2 Determination of Dead Load

$$W = 33103.50 \text{ kip} \quad (\text{from ETABS analysis model})$$

4.2.1 Water tank on roof

Total weight of water tank = $82500 \times 2\text{lb} = 165000 \text{ lb} = 165 \text{ kip}$

Therefore, seismic dead load,

$$W = 33103.50 \text{ kip} \quad (\text{from ETABS analysis model})$$

4.3 Earthquake Load Calculation

Table 4.1: Seismic Zone Coefficient, Z

Seismic Zone	Zone Coefficient
1	0.075
2	0.15
3	0.25

Table 4.2: Structure Importance Coefficient, I & I' (BNBC, Table-6.2.23)

Structure importance categories	Structure Importance Coefficient	
	I	I'
Essential facilities	1.25	1.50
Hazardous facilities	1.25	1.50
Special occupancy structures	1.00	1.00
Standard occupancy structures	1.00	1.00
Low-risk structures	1.00	1.00

$$\text{Design base shear, } V = \frac{ZIC}{R}W$$

Where,

$$Z = \text{Seismic zone coefficient} = 0.15 \quad [\text{for zone-2, BNBC Table - 6.2.22}]$$

$$I = \text{Structural Importance coefficient} = 1 [\text{BNBC, Table-6.2.23}]$$

$$R = \text{Response modification coefficient} = 12$$

$$C = \text{Seismic coefficient} = \frac{1.25S}{T^{2/3}}$$

In which S = Site coefficient for soil characteristics = 1.5

$$T = \text{Fundamental period of vibration} = C_t h_n^{3/4}$$

$$\text{Where, } C_t = 0.073 \quad [\text{for RCC moment resisting frame}]$$

$$h_n = \text{Building height in meter above base level} = 132 \text{ ft} = 40.24 \text{ m}$$

$$\therefore T = C_t h_n^{3/4} = 0.073 \times (40.24)^{3/4} = 1.17 \text{ sec} \quad [T > 0.7]$$

and

$$C = \frac{1.25S}{T^{2/3}} = \frac{1.25 \times 1.5}{1.17^{2/3}} = 1.69 < 2.75 \quad (\text{ok})$$

$$\text{Design base shear (for Dhaka) } V = \frac{ZIC}{R}W = \frac{0.15 \times 1 \times 1.69}{12} \times 33103.50 = 699.31 \text{ kip}$$

4.3.1 Vertical distribution of lateral force

$$\text{Lateral force applied at story level } i, \quad F_i = \frac{(V - F_t)W_i h_i}{\sum W_i h_i} = \frac{(V - F_t)h_i}{\sum h_i}$$

$$\text{Since } T > 0.7, \text{ Additional force to be add at roof, } F_t = 0.07TV = 0.07 \times 1.17 \times 699.31 = 57.27 \text{ kip} \leq 0.25 V = (0.25 \times 699.31) = 174.83 \text{ kip} \quad (\text{ok})$$

Where F_t = Concentrated lateral force considered at the top of the building in addition to the force $F_n = 51.69$ kip

$$\begin{aligned}
 F_i &= \frac{VF_i}{\sum h_i} \\
 &= \frac{699 - 57.27}{11(1+2+3+4+5+6+7+8+9+10+11+12)+11} \times h_i \\
 &= 0.77 h_i
 \end{aligned}$$

Table 4.3: Earthquake load at the story level (zone-II)

$B_I=11$ ft	$F_{B_I} = 0.77 \times 11 = 8.47$ kip
GF =22ft	$F_{GF} = 0.77 \times 22 = 16.94$ kip
$L_1=33$ ft	$F_1 = 0.77 \times 33 = 25.41$ kip
$L_2=44$ ft	$F_2 = 0.77 \times 44 = 33.88$ kip
$L_3=55$ ft	$F_3 = 0.77 \times 55 = 42.35$ kip
$L_4=66$ ft	$F_4 = 0.77 \times 66 = 50.82$ kip
$L_5=77$ ft	$F_5 = 0.77 \times 77 = 59.29$ kip
$L_6=88$ ft	$F_6 = 0.77 \times 88 = 67.76$ kip
$L_7=99$ ft	$F_7 = 0.77 \times 99 = 76.23$ kip
$L_8=110$ ft	$F_8 = 0.77 \times 110 = 84.7$ kip
$L_9=121$ ft	$F_9 = 0.77 \times 121 = 93.17$ kip
Roof =132ft	$F_{Roof} = 0.77 \times 132 = 101.64$ kip

Total force to be applied at roof, $(101.64 + 57.27) = 158.91$ kip

4.4 Wind Load Calculation

Length of building, L	= 90'-2"
Width of building, B	= 109'-5"
Height of building, H	= 132'
Wind pressure in Dhaka city, V_b	= 210 km/h
Exposure	= A
Importance coefficient for hotel building, C_i	= 1
Velocity to pressure conversion coefficient, C_c	= 0.0000472

$$H/B = 1.21 \text{ and } L/B = 0.82$$

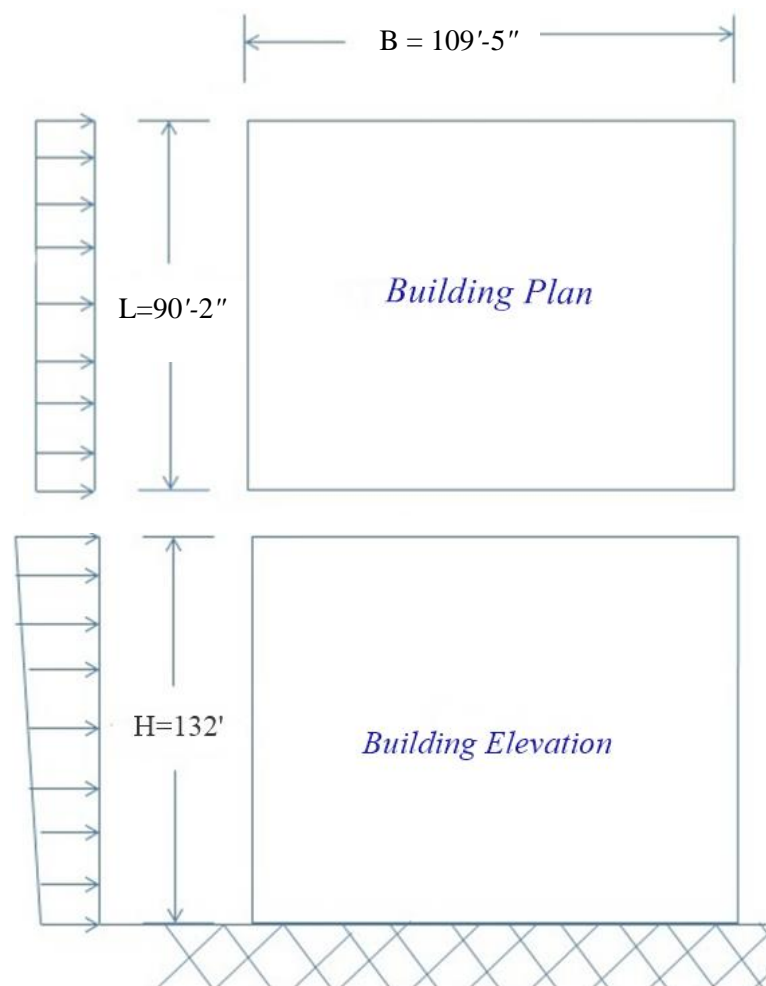

Figure 4.1: Wind load application on the building across short direction

So, from Table 6.2.15 of BNBC we can find windward coefficient C_p .

Story range = Ground floor to Top.

Sustained wind pressure, $q_z = 0.0000472 \times 1 \times C_z \times 210^2 = 2.08152 C_z$

Wind from Short side

From Chart According to the BNBC code corresponding H/B and L/B,

Pressure coefficient, $C_p = 1.53$

Wind pressure $P_z = C_G \times C_p \times q_z$

$$= C_G \times 1.53 \times 2.08152 C_z = 3.20 C_G C_z$$

Table 4.4: Estimation of design wind pressure

Storey	Height m	C_z	q_z	C_G	P_z kN/m ²	Area m ²	F kN
Roof	40.24	0.967	2.01	1.253	3.88	27.30	106
11th	36.89	0.930	1.91	1.275	3.79	27.30	103
10th	33.53	0.891	1.85	1.303	3.72	27.30	101
9th	30.18	0.851	1.77	1.288	3.51	27.30	95
8th	26.83	0.808	1.68	1.341	3.47	27.30	94
7th	23.48	0.761	1.58	1.359	3.31	27.30	90
6th	20.12	0.711	1.48	1.381	3.14	27.30	86
5th	16.77	0.655	1.36	1.406	2.95	27.30	80
4th	13.41	0.593	1.23	1.436	2.72	27.30	74
3rd	10.06	0.521	1.08	1.476	2.46	27.30	67
2nd	6.71	0.434	0.90	1.573	2.18	27.30	60
1st	3.35	0.368	0.76	1.654	1.95	27.30	53
G. F	0	0	0	0	0	0	0

CHAPTER 5

STUDY METHOD AND ANALYSIS OF THE BUILDING

5.1 Introduction

Extended 3D analysis of Building System (ETABS) is a nonlinear analysis software specially designed for building frame system. Dating back more than 30 years to the original development of ETABS, structure analysis for buildings is easy and simple for both lateral and gravity loads. In this chapter, a briefed script on about planning, modeling, analysis and design of the twenty storied residential building is provided.

5.2 Study Procedure

Step-1: Selection and planning of the structure

Twenty storied frame structure with edge supported floor system and having same plinth areas with different floor plans had been selected to study. The whole structure is a residential building having all the essential facilities in the building.

Step-2: Selection of the material properties & loadings

Material properties (compressive strength of concrete, yield stress of steel, unit weight of concrete, brick etc.) and loadings (service dead and live loads) were selected. Wind and earthquake loads were also considered as horizontal loading for the building.

Step-3: Modeling

To analyze a building frame in ETABS modeling of the building frame is mandatory. To create the model grid data and storey data were setup from the building plan grid .system and storey data definition tabA 3D solid element model for analyzing the twelve storied reinforced concrete building is developed using ETABS structural analysis software. The 3D ETABS analysis model of twelve storied reinforced concrete building is shown in Figure 5.1. The ultimate strength for concrete and yielding stress and ultimate strength for steel are considered 4 ksi, and 60 ksi respectively.

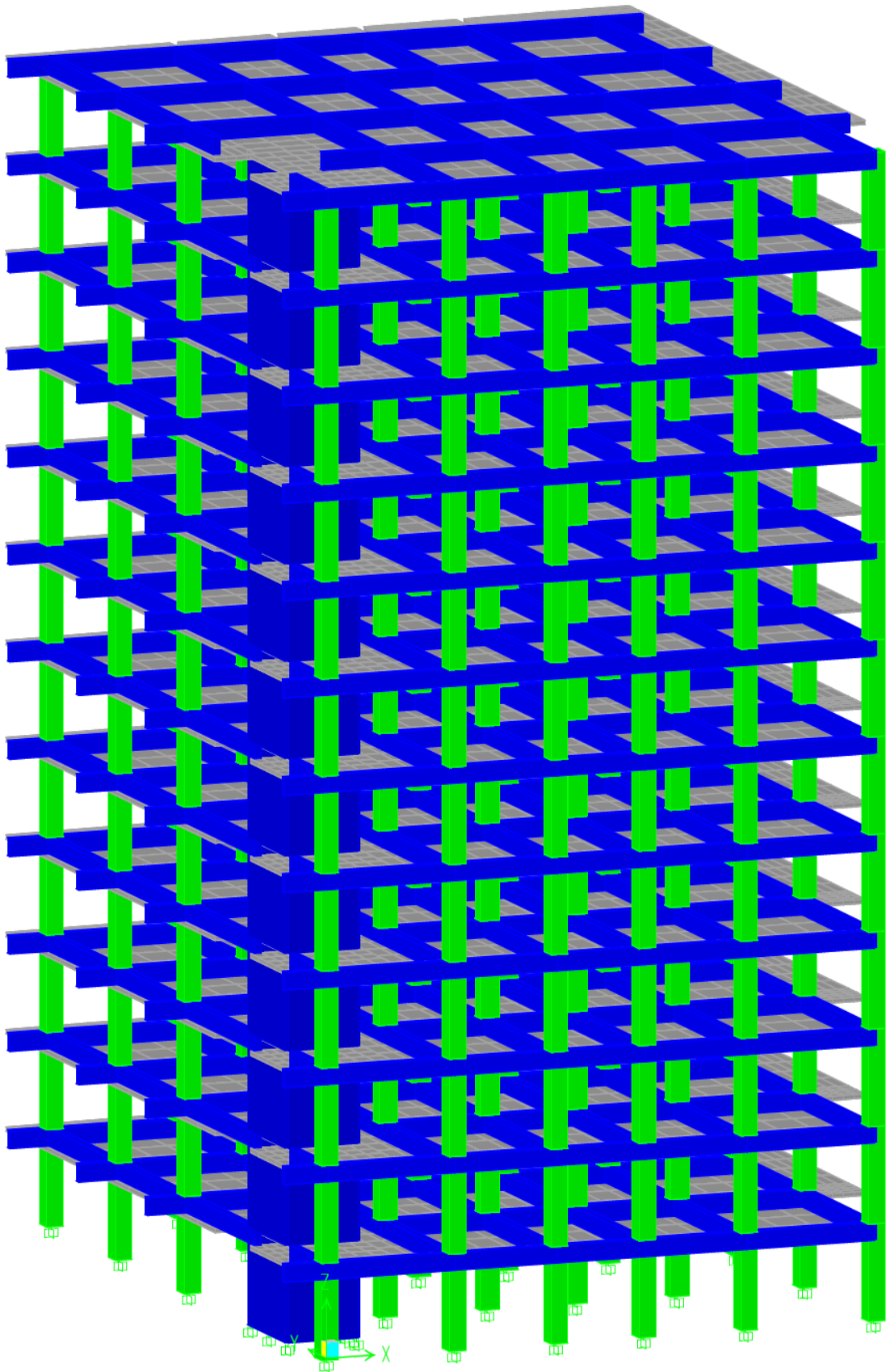

Figure 5.1: 3D view of structural frame model of the proposed building

Live and dead loads are applied as gravity load and wind load and earthquake load are considered as lateral load in the analysis. Loads of partition walls, floor finish and self-weight of the structures are treated as dead load and live load is taken from BNBC. In the modeling, dead and live loads are assigned as vertical distributed load on all floor surfaces. Earthquake loads are calculated following equivalent static load method for each story levels and assigned horizontally together with wind load at each beam-column joint of exterior surface of the building as user defined loads.

Section defines in ETABS

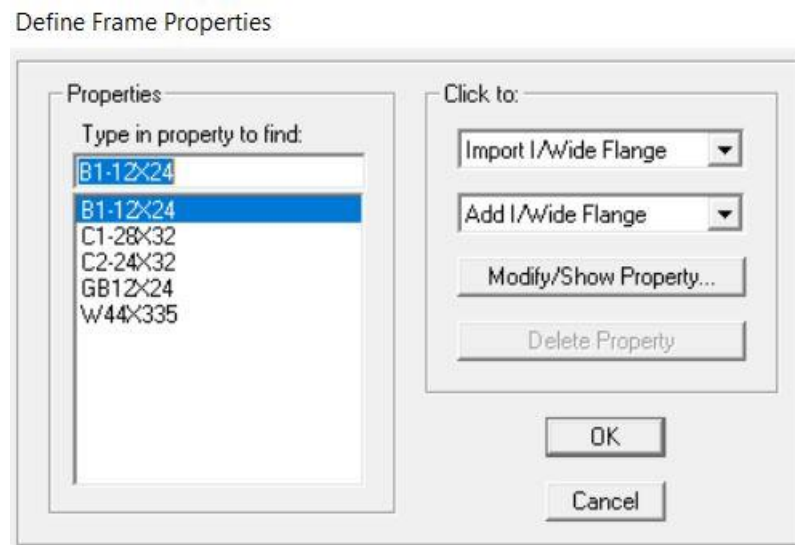

Figure 5.2: Define frame section of the proposed building

Define load case in ETABS

Define Static Load Case Names

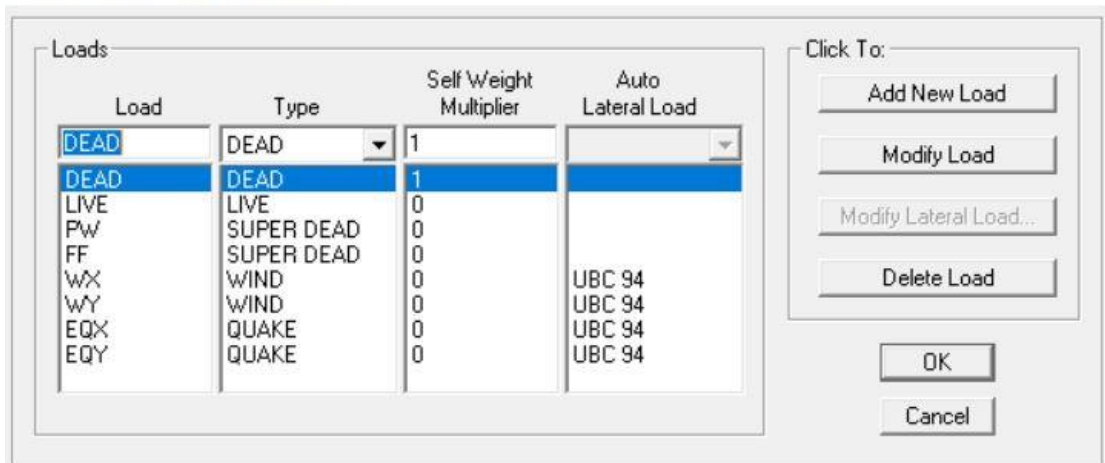

Figure 5.3: Define load case of the proposed building

Step-4: Analysis and design of the structure:

The structure is analyzed by using ETABS and corresponding design calculations are provided in the successive Chapters

5.3 Design data and specifications considered in this study

The whole study was carried out based on few considerations and specifications which are followings:

1. Design code: Bangladesh National Building Code (*BNBC*), 1993.
American Concrete Institute (*ACI*) Building design code, 2008.
2. Loadings: Dead load= 105 psf
Live load = 100psf (Lobby & Stair Case), 60 psf (hospital area) & 150 psf (Ramp area)
Earthquake and wind load are considered and calculation.
3. Building components: Column type = Tied column.
Slab thickness= 6 *inch*.
Thickness of all walls = 5 *inch*.
Beam type= singly beam.
4. Material properties: Yield strength of reinforcing bars, $f_y = 60,000$ psi.
Concrete compressive strength, $f'_c = 3500$ psi.
Normal density concrete having $w_c = 150$ pcf
Unit weight of brick, $w_b = 120$ pcf.
Maximum Steel ratio for column, $\rho_g = 5\%$ of A_g
5. Sectional properties of column: C1=28×32 inch
C2=24×32 inch
6. Sectional properties of Beam: FB= 12×24 inch

5.4 Results of 3D Model Analysis:

3D finite element analysis models are developed based on actual shape of the buildings using ETABS structural analysis software. Besides the gravity loads, wind and earthquake loads, material property definitions, boundary conditions and element

Geometrical property definitions are also generated in the analysis models and run the analysis programs of the models for static analysis in ETABS analysis platform. Results produced by the analysis are illustrated in the following Figures.

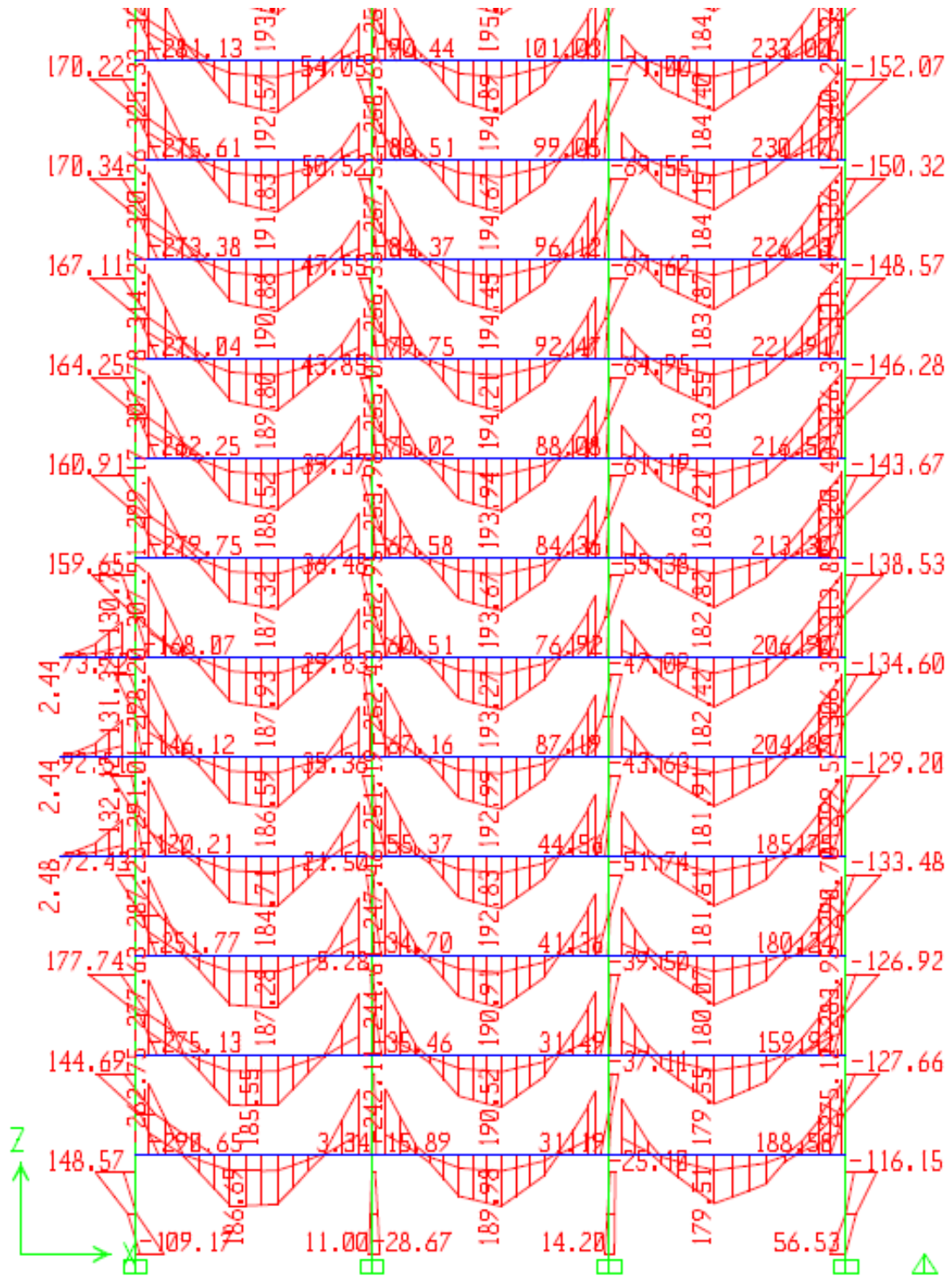

Figure 5.4: Bending Moment Diagram of Columns and Beams on 5-5 Grid (kip-ft)

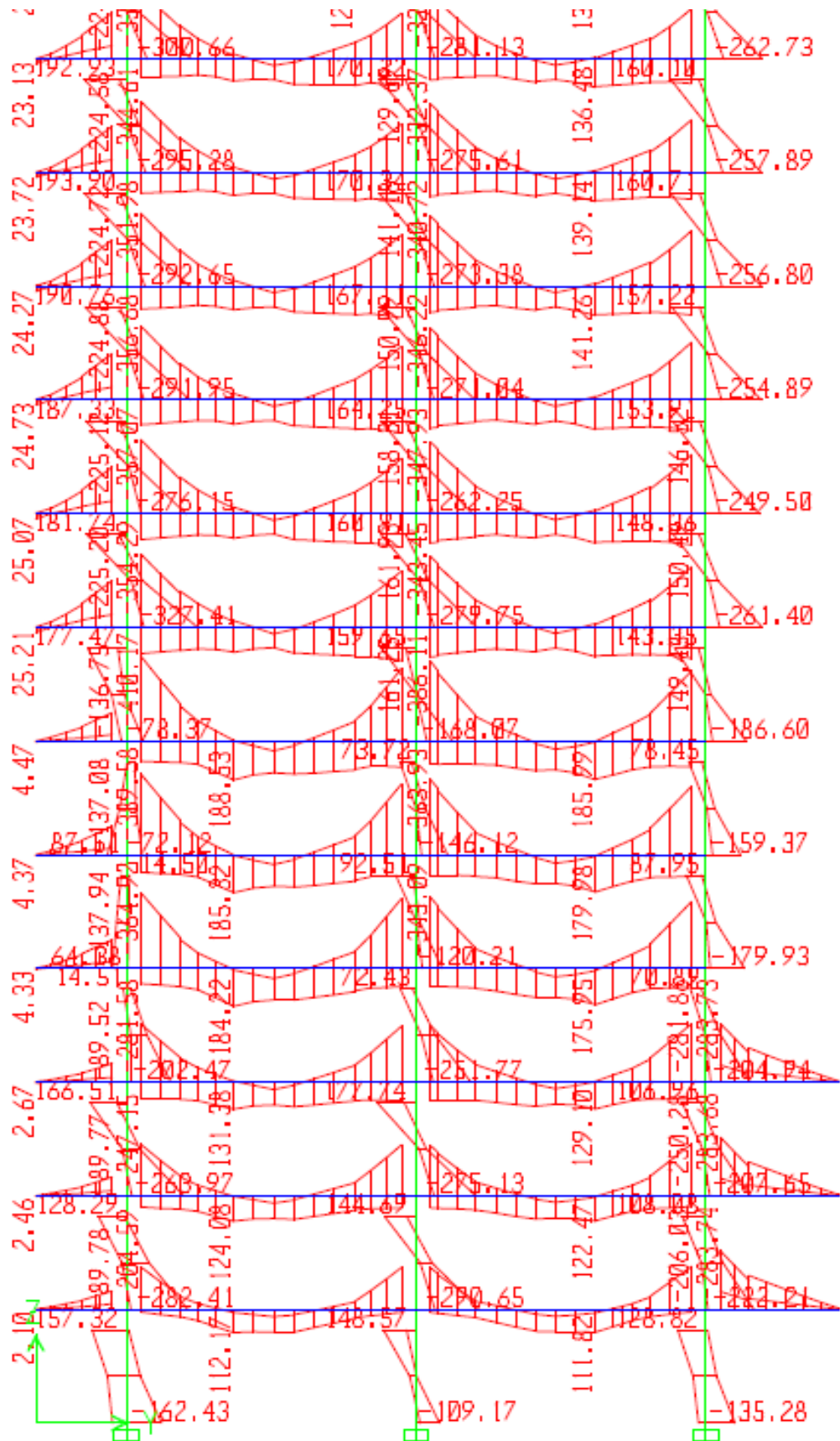

Figure 5.5: Bending Moment Diagram of Columns and Beams on C-C Grid (kip-ft)

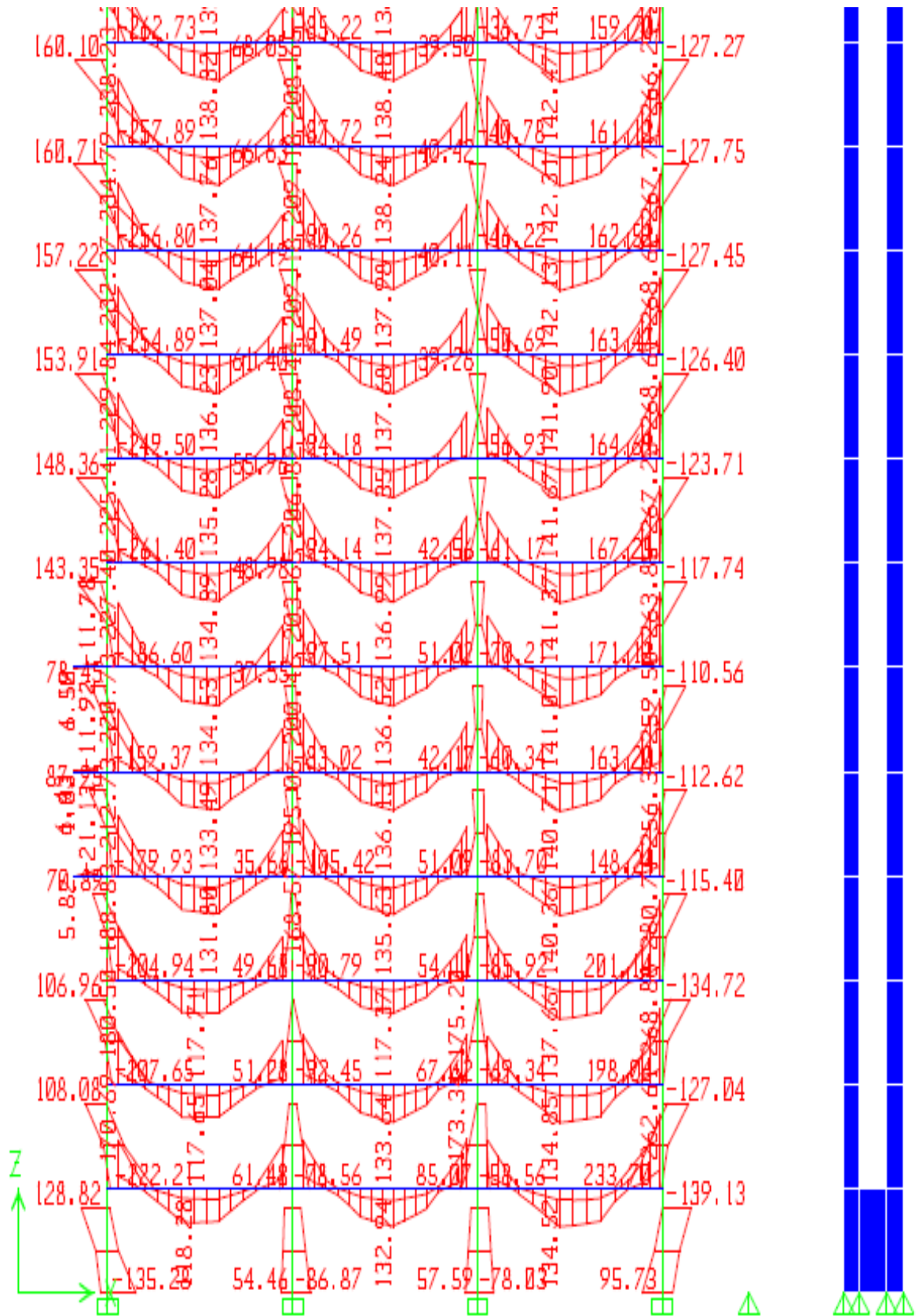

Figure 5.6: Bending Moment Diagram of Columns and Beams on 7-7Grid (kip-ft)

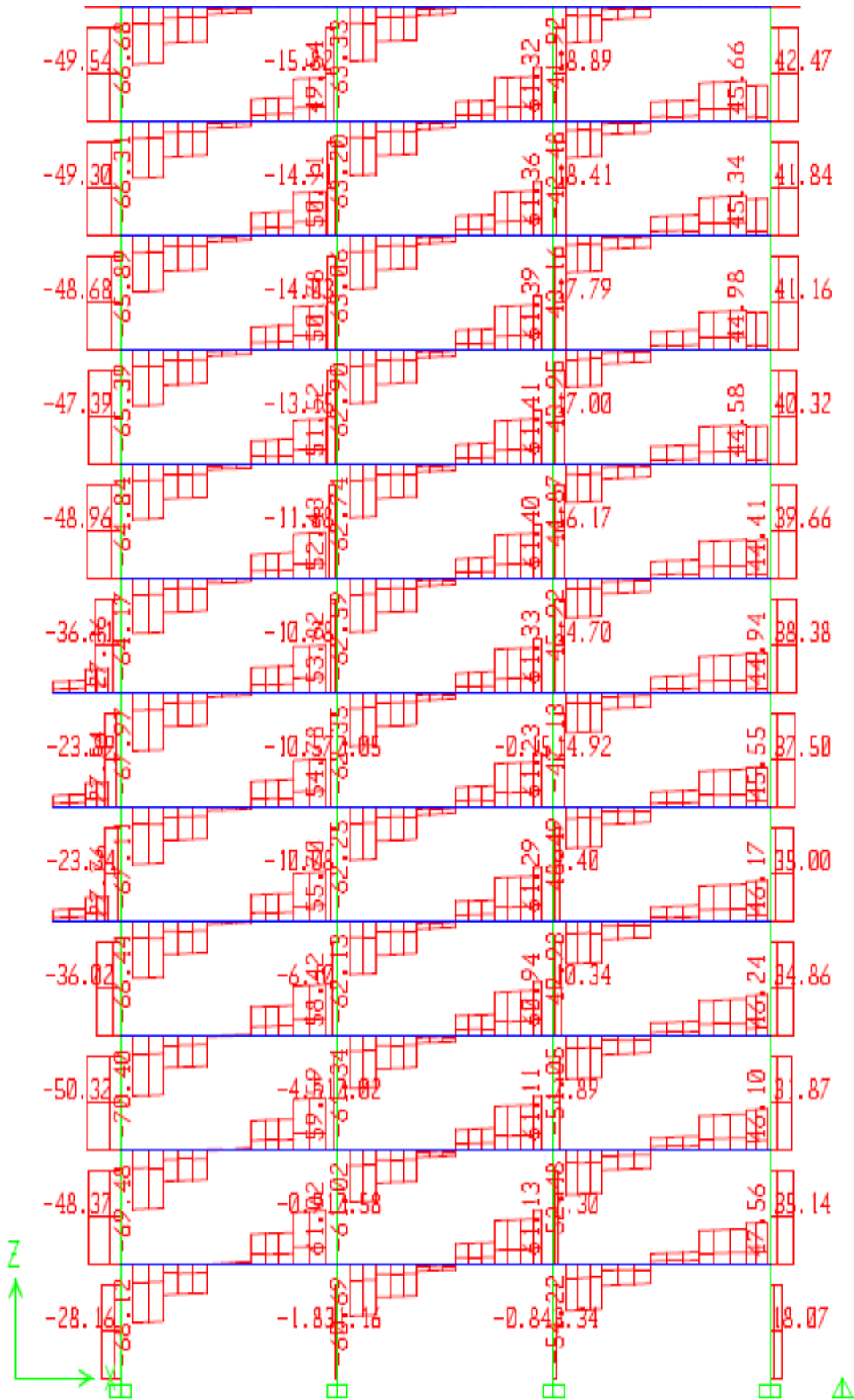

Figure 5.7: Shear Force Diagram of Beams on 5-5 Grid (kips)

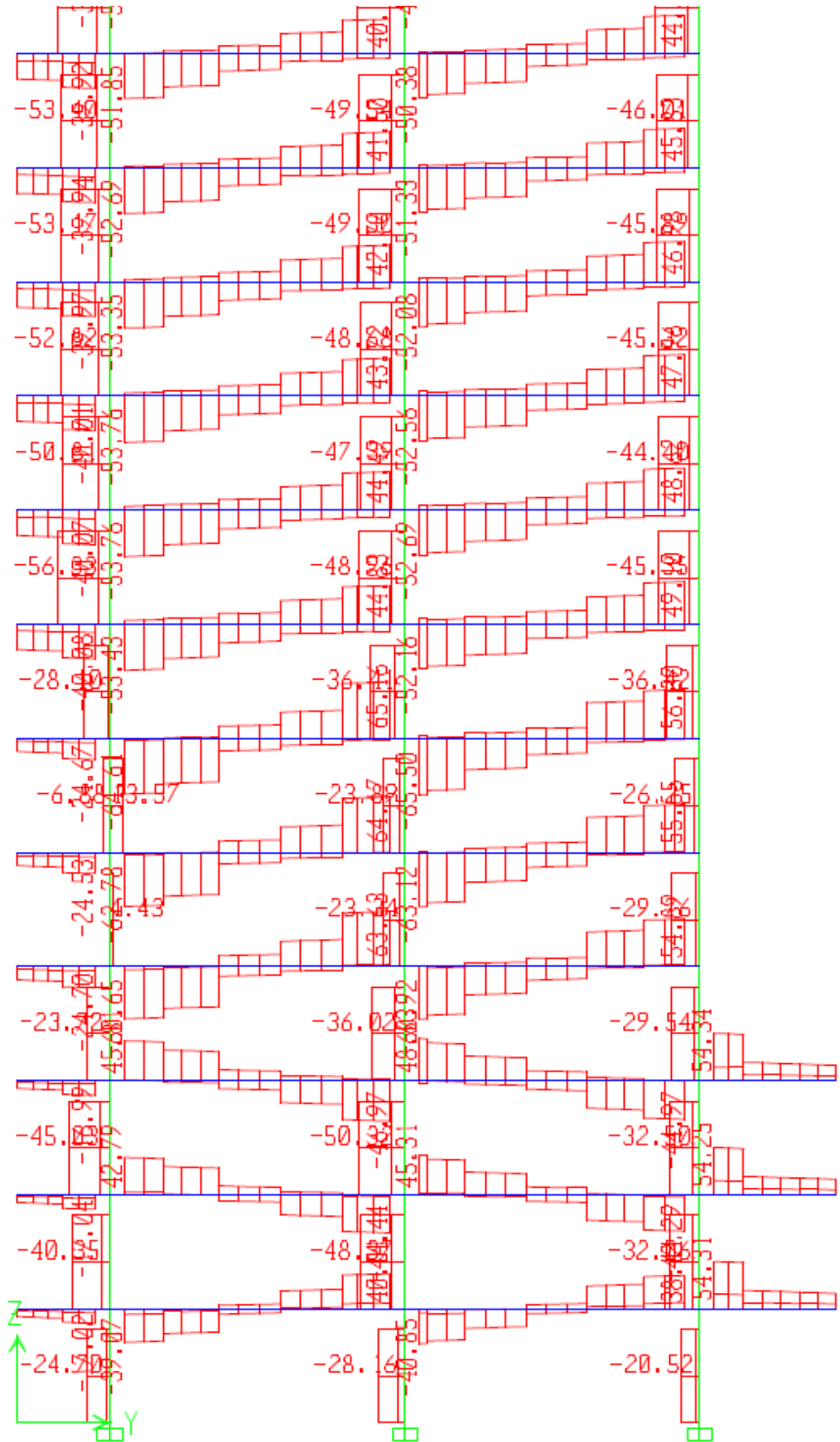

Figure 5.8: Shear Force Diagram of Beams on C-C Grid (kips)

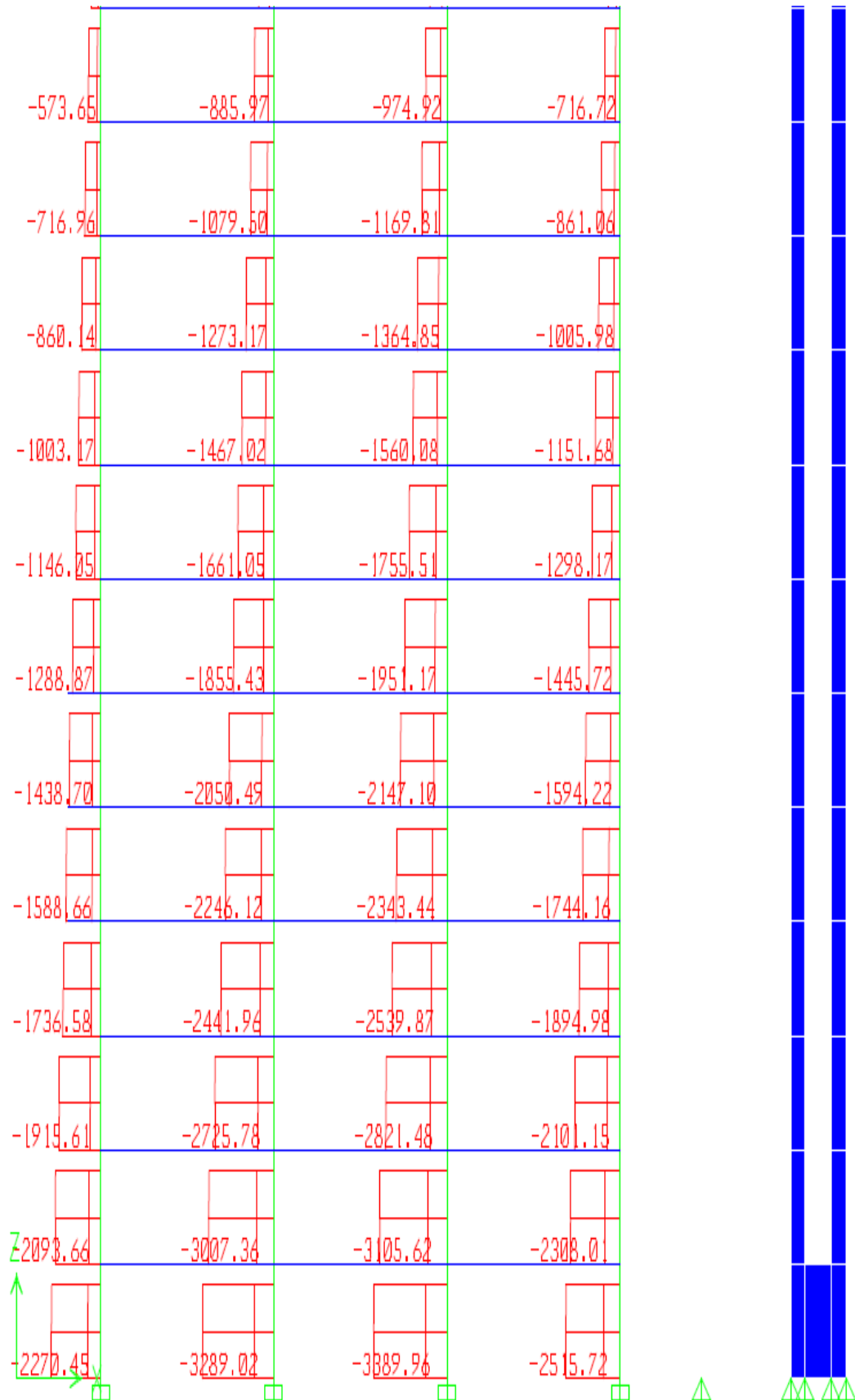

Figure 5.9: Axial Force Diagram of columns on 7-7 Grid (kips)

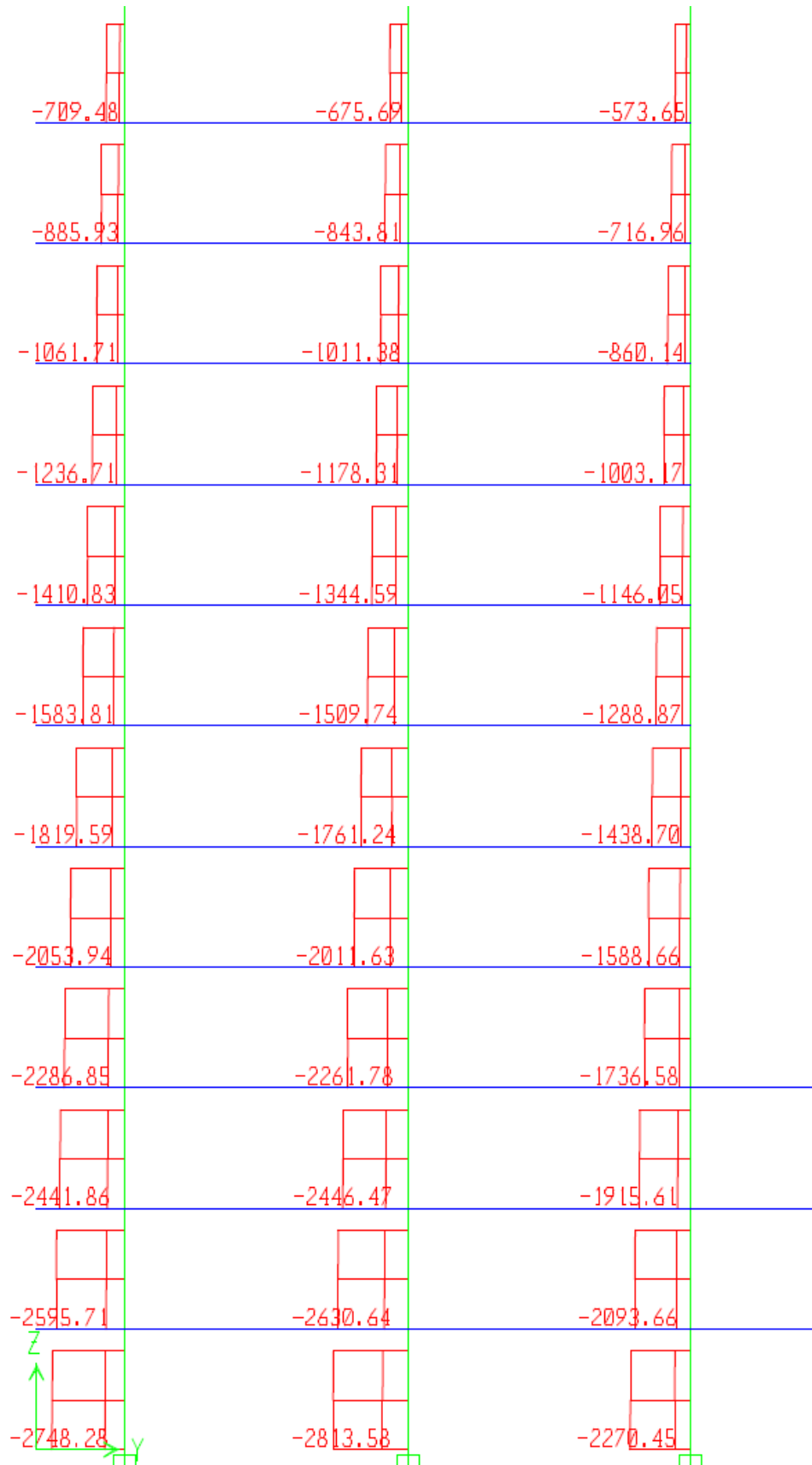

Figure 5.10: Axial Force Diagram of columns on C-C Grid (kips)

CHAPTER 6

DESIGN OF SLAB

6.1 Introduction

The whole design is carried out based on few considerations and specifications which are given below:

- Design Method : Ultimate Strength Design (*USD*)
- Design Procedure : Equivalent Frame Method
- Design Code : BNBC 1993 and ACI 2008
- Types of structures : Edge Supported floor system
- Building System : Frame Structure High rise Building (12 storied)
- Material properties
 - : 60 Grade reinforcing bars having $f_y = 60,000$ psi
 - : Concrete compressive strength, $f'_c = 3500$ psi
 - : Normal density concrete having $w_c = 150$ pcf
 - : Unit weight of brick, $w_b = 120$ pcf
 - : Steel ratio for column, $\rho_g = 2$ to 6%
 - : Ratio of the ingredients = 1: 1.5: 3
 - : FM of normal sand = 2.5
- Loadings
 - : Dead load = 105 psf
 - : Live load = 100 psf (lobby and staircase),
60 psf (hospital area) & 150psf (ramp area)
 - : Beam wall load = 350 psf
 - : Wind and Earthquake load are considered
- Slab Section properties
 - : Slab type = Two-way
 - : Beam type = Singly rectangular
 - : Column type = Tied
 - : Grade beam position = 11 ft. from footing base level
 - : Thickness of all walls = 5 in

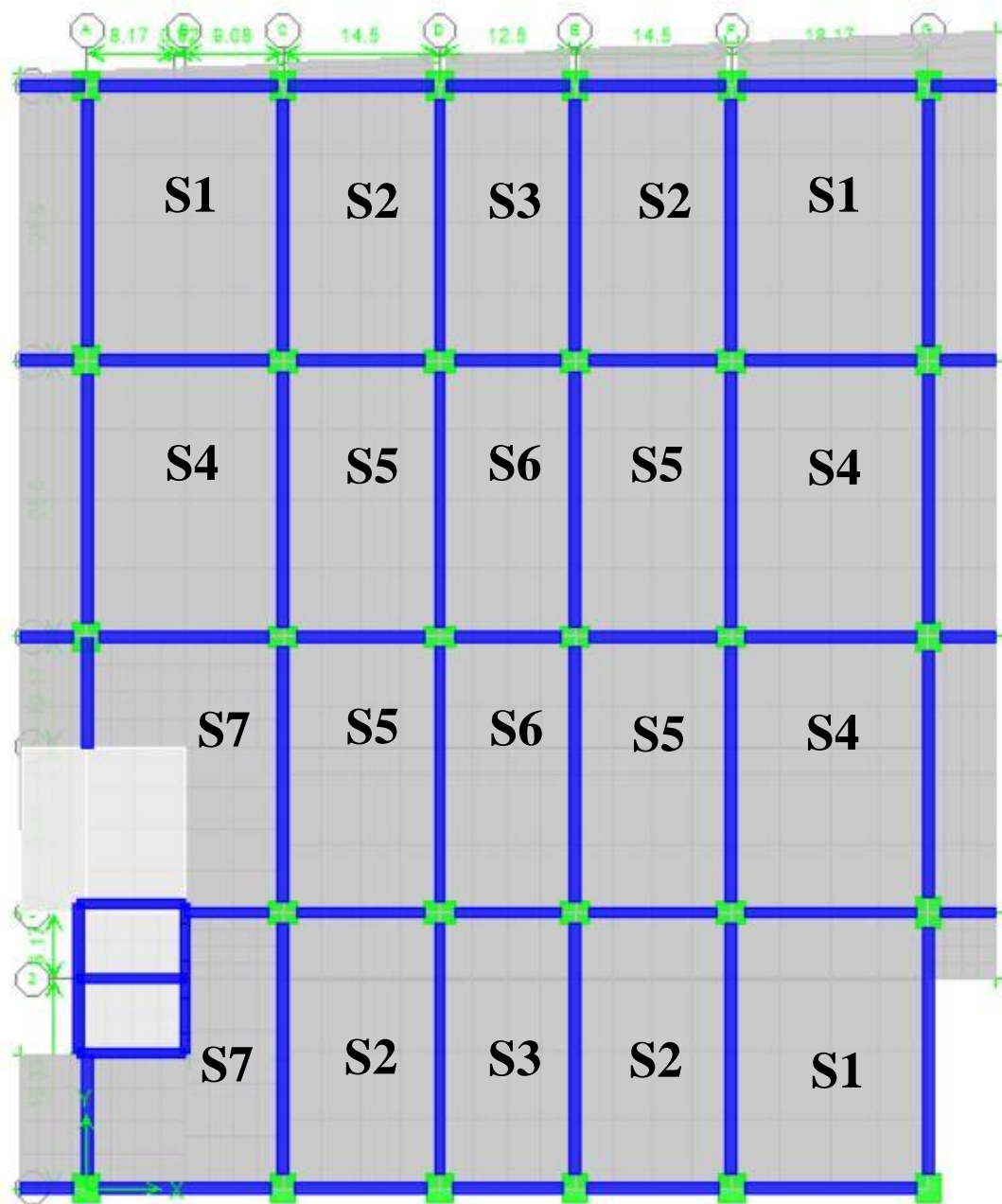

Figure 6.1: Panel layout plan

6.2 Design of slab Panel S1

6.2.1 Design data

Material Properties: $f'_c = 3500$ psi

$$f_y = 60000 \text{ psi}$$

Beam width = 12 in

6.2.2 Check of effective depth of the slab

Maximum moment $M_{max} = 6.98$ kip-ft

Assume panel thickness, $h = 6$ in

Effective depth of the slab, $d = 6 - 1 = 5$ in, $M_{max} = 6.98$ kip-ft

$$d_{req} = \sqrt{\frac{M_{max}}{\phi \times \rho_{max} \times b \times f_y \times (1 - 0.59 \times \rho \times \frac{f_y}{f'_c})}}$$

$$d_{req} = \sqrt{\frac{6.98 \times 12 \times 1000}{0.90 \times 0.0160 \times 12 \times 60000 \times (1 - 0.59 \times 0.0160 \times \frac{60000}{3500})}}$$

$$d_{req} = 3.11" < d_{prov} = 5" \quad (\text{ok})$$

6.2.3 Calculation of reinforcement

Minimum reinforcement calculation:

$$A_{s\ min} = 0.0018\ bd = 0.0018 \times 12 \times 5 = 0.108\ \text{in}^2$$

$$S = 0.11 \times 12 / 0.108 = 12.22\ \text{in}$$

$$S_{max} = 2h = 2 \times 6 = 12\ \text{in}$$

$$S_{max} = 18\ \text{in}$$

So, provide #3bars with $S = 12$ in c/c as temperature and shrinkage reinforcement.

X direction at mid span (positive steel):

$$M_u = 6.98\ \text{kip-ft}$$

$$\rho = \frac{0.85 f'_c}{f_y} \left(1 - \sqrt{1 - \frac{2M_u}{0.85 \phi f'_c b d^2}} \right)$$

$$\rho = \frac{0.85 \times 3.5}{60} \left(1 - \sqrt{1 - \frac{2 \times 6.98 \times 12}{0.85 \times 0.9 \times 3.5 \times 12 \times 5^2}} \right) = 0.0055$$

$$\text{Now, } A_{st} = \rho b d = 0.0055 \times 12 \times 5 = 0.33\ \text{in}^2 > A_{s\ min} = 0.108\ \text{in}^2 \quad (\text{ok})$$

$$\text{Spacing } S = \frac{A_b \times 12}{A_{st}} = \frac{0.11 \times 12}{0.33} = 4\ \text{in}$$

Provide #3@4 in c/c in X direction as positive reinforcement.

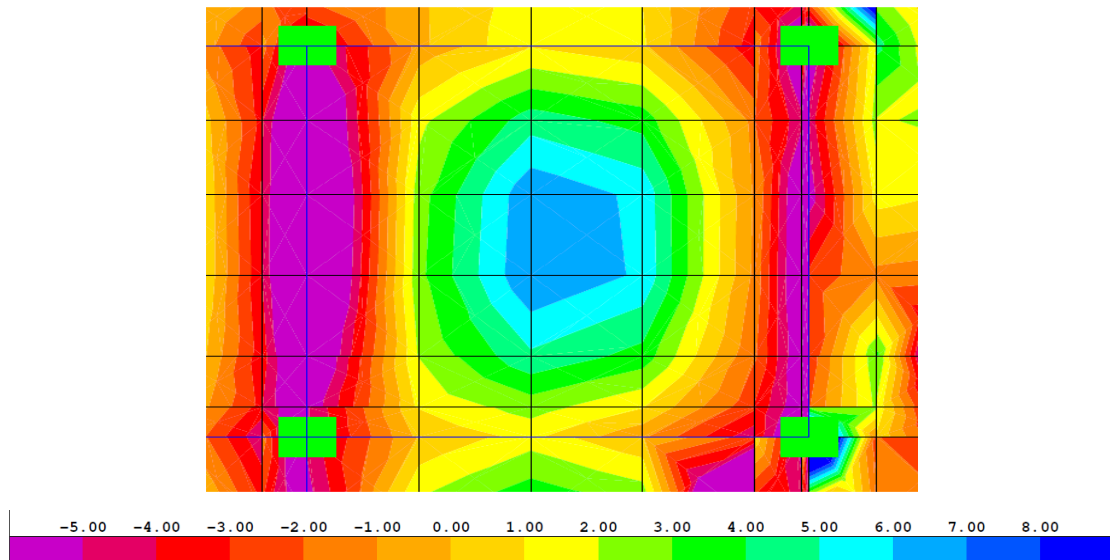

Figure: 6.2.1: Moment at panel S1 (in X-direction)

X direction at interior support (negative steel):

$$M_u = 10.53 \text{ kip-ft}$$

$$\rho = \frac{0.85 f'_c}{f_y} \left(1 - \sqrt{1 - \frac{2M_u}{0.85 \phi f'_c b d^2}} \right)$$

$$\rho = \frac{0.85 \times 3500}{60000} \left[1 - \sqrt{1 - \frac{2 \times 10.53 \times 12 \times 1000}{0.85 \times 0.9 \times 3500 \times 12 \times 5^2}} \right] = 0.0085$$

$$\text{Now, } A_{st} = \rho b d = 0.0085 \times 12 \times 5 = 0.51 \text{ in}^2 > A_{s \text{ min}} = 0.108 \text{ in}^2 \quad (\text{ok})$$

$$\text{Spacing} = \frac{A_b \times 12}{A_{st}} = \frac{0.11 \times 12}{0.51} = 2.58 \text{ in} = 2.5 \text{ in c/c}$$

Provide #3@ 2.5 in c/c in X direction.

Y direction at mid span (positive steel)

$$M_u = 6.73 \text{ kip-ft}$$

$$\rho = \frac{0.85 f'_c}{f_y} \left(1 - \sqrt{1 - \frac{2M_u}{0.85 \phi f'_c b d^2}} \right)$$

$$\rho = \frac{0.85 \times 3500}{60000} \left(1 - \sqrt{1 - \frac{2 \times 6.73 \times 12 \times 1000}{0.85 \times 0.9 \times 3500 \times 12 \times 5^2}} \right) = 0.0053$$

$$A_{st} = \rho b d = 0.0053 \times 12 \times 5 = 0.318 \text{ in}^2 > A_{s \text{ min}} = 0.108 \text{ in}^2 \quad (\text{ok})$$

$$\text{Spacing} = \frac{A_b \times 12}{A_{st}} = \frac{0.11 \times 12}{0.318} = 4.15 \text{ in} = 4 \text{ in c/c}$$

Provide #3@ 4 in c/c in Y direction.

Y direction at interior support (negative steel)

$$M_u = 9.60 \text{ kip-ft}$$

$$\rho = \frac{0.85 f'_c}{f_y} \left(1 - \sqrt{1 - \frac{2M_u}{0.85 \phi f'_c b d^2}} \right)$$

$$\rho = \frac{0.85 \times 3500}{60000} \left(1 - \sqrt{1 - \frac{2 \times 9.60 \times 12 \times 1000}{0.85 \times 0.9 \times 3500 \times 12 \times 5^2}} \right)$$

$$= 0.0077$$

$$\text{Now, } A_{st} = \rho b d = 0.0077 \times 12 \times 5 = 0.462 \text{ in}^2 (\text{ok})$$

$$A_{s \text{ min}} = 0.0018 b d = 0.0018 \times 12 \times 5 = 0.108 \text{ in}^2$$

$$\text{Spacing} = \frac{A_b \times 12}{A_{st}} = \frac{0.11 \times 12}{0.462} = 2.85 \text{ in} \equiv 2.75 \text{ in c/c}$$

$$S_{max} = 2h = 2 \times 6 = 12''$$

$$S_{max} = 18''$$

Provide #3@2.75 in c/c in Y direction.

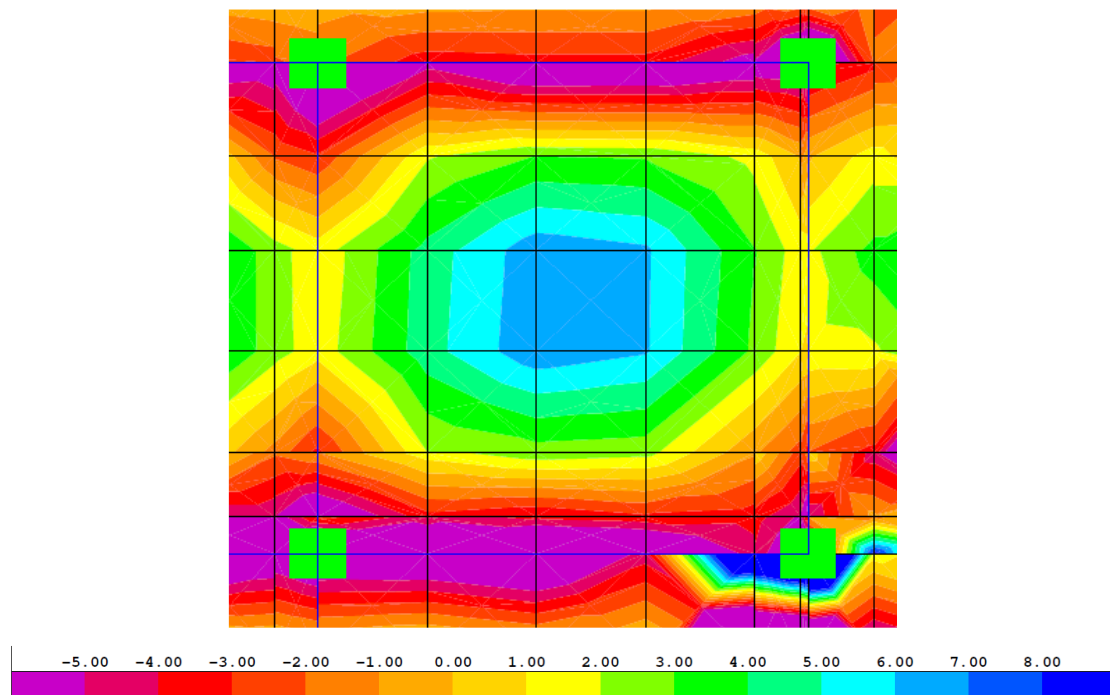

Figure: 6.2.2: Moment at panel S1 (in Y- direction)

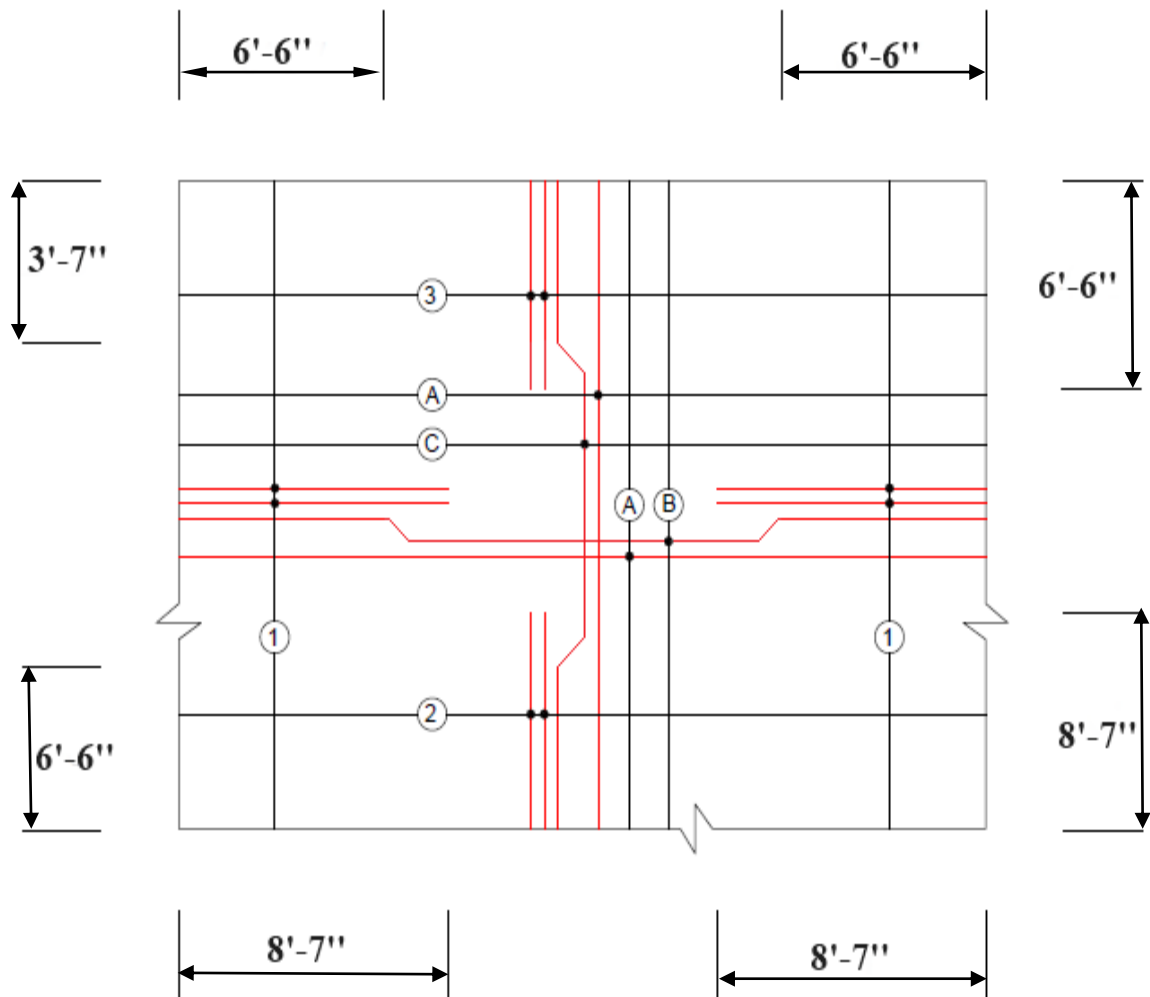

Figure 6.3: Reinforcement detailing of slab panel S1

Table 6.1: Detail of reinforcement arrangement of slab panel S1

ID	Location	Bar Provided
A	Temperature and shrinkage reinforcement	#3 @ 12 in c/c
B	Y-direction at mid span (positive reinforcement)	#3 @4.0 in c/c
C	X-direction at mid span (positive reinforcement)	#3 @4.0 in c/c
1	X-direction at interior support (negative reinforcement)	#3 @2.5 in c/c
2	X-direction at exterior support (negative reinforcement)	#3 @2.5 in c/c
3	Y-direction at interior support (negative reinforcement)	#3 @2.75 in c/c

Corner Reinforcement:

Use #3@12" c/c reinforcement from the corner of the corner panel of range $l_{max}/5 = (26.67 \times 12) / 5 = 64"$ (1/5 of longer span) for both directions.

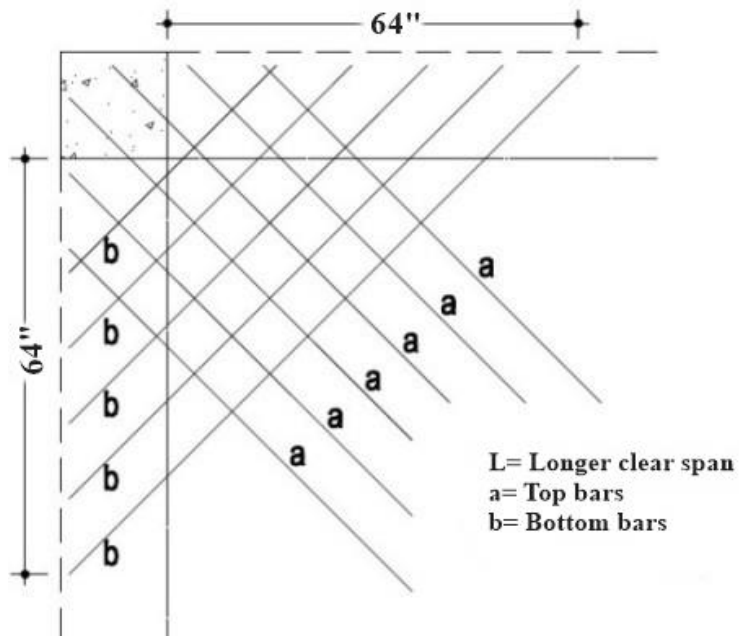

Figure 6.4: Detail of corner Reinforcement

CHAPTER 7

DESIGN OF BEAM

7.1 Introduction

This chapter includes details of beam design. There are several beams in the twelve storied hospital building. The building frame model including all beam is analyzed using ETABS. Beam layout plan of 5th story is shown in Figure 7.1. For space limitation, detail design calculation of interior beam FB of 5th storey is provided in this chapter, whereas calculation for some beams is shown in tabulated format.

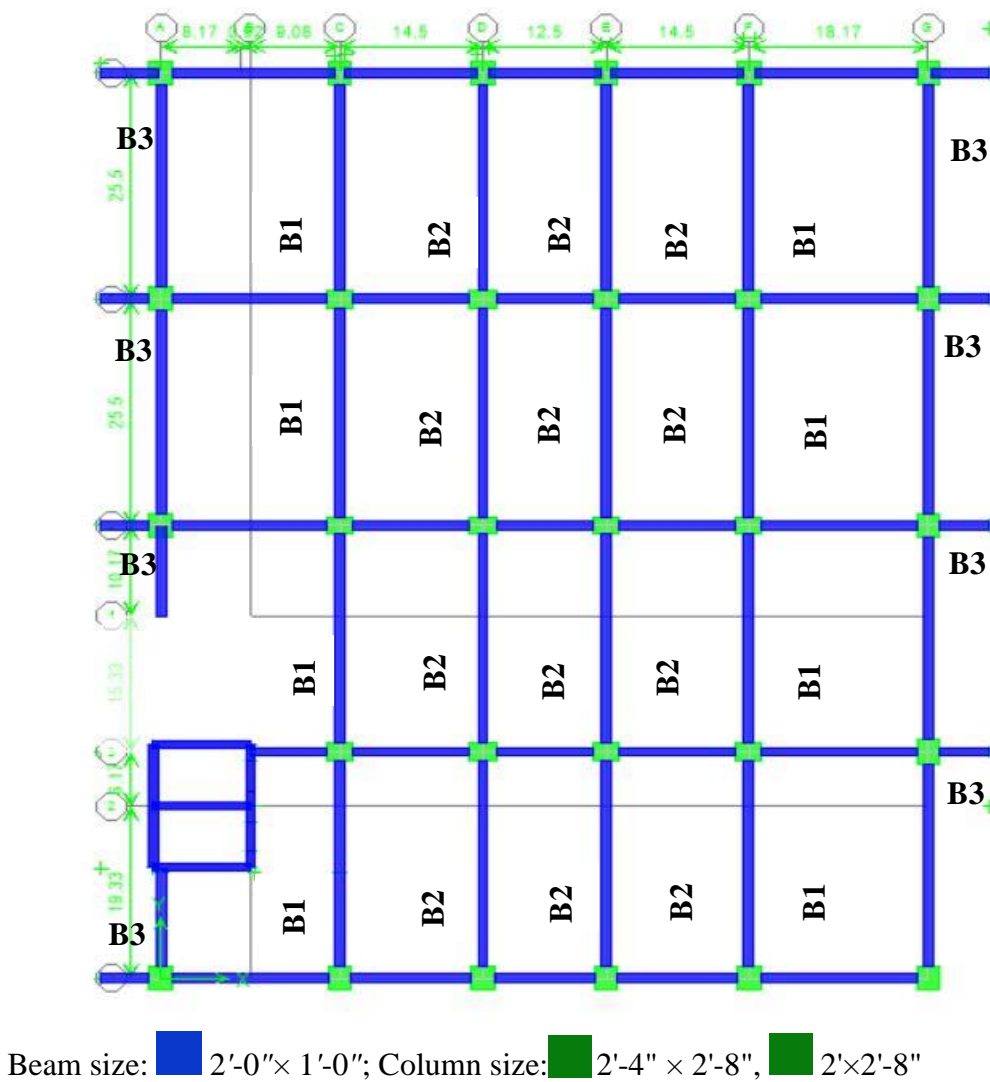

Figure 7.1: Beam layout plan

7.2 Design of Exterior Beam

7.2.1 Design data

$$f_y = 60 \text{ ksi}$$

$$f'_c = 3.5 \text{ ksi}$$

Clear span of the beam = 25.6'

Assume, beam section width, $b = 12''$ and beam section depth, $h = 24''$

Column size, $C1=28'' \times 32''$, $C2=24'' \times 32''$

The following bending moments of beam are collected from ETABS analysis results

+ve Moment at Mid Span = 188.53 kip-ft

-ve Moment at Interior Span = 410.17 kip-ft

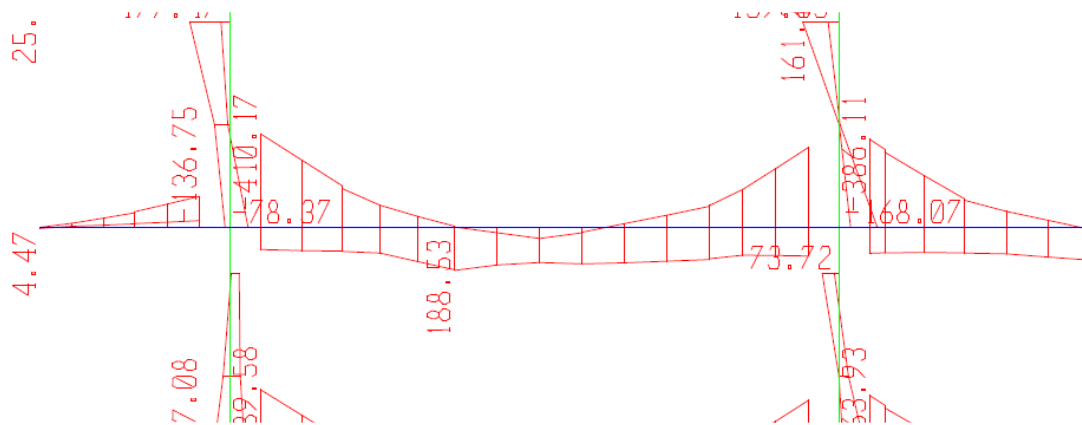

Figure 7.2: Maximum design moment of the Beam (from ETABS results file)

7.2.2 Maximum Steel Ratio

$$\rho_b = 0.85 \times \beta_1 \times \frac{f'_c}{f_y} \times \frac{87}{87 + f_y} = 0.85 \times 0.85 \times \frac{3.5}{60} \times \frac{87}{87 + 60} = 0.0249$$

$$\rho_{\max} = 0.63375 \times \rho_b = 0.63375 \times 0.0249 = 0.0158$$

$$d = h - \text{clear cover} = 24 - 3.5 = 20.5 \text{ in}$$

7.2.3 Reinforcement Calculation

Interior Span: Reinforcement at support

$$M_u = 410 \times 12 = 4920 \text{ kip-in}$$

First check whether the beam as singly reinforced can carry the moment.

$$M_{u1} = \phi \times \rho \times b \times d^2 \times f_y \times \left(1 - 0.59 \times \rho_{\max} \times \frac{f_y}{f'_c} \right)$$

$$M_{u1} = 0.9 \times 0.0158 \times 12 \times (20.5)^2 \times 60 \times \left(1 - 0.59 \times 0.0158 \times \frac{60}{3.5} \right)$$

$$M_{u1} = 3615 \text{ kip-in} < M_u = 4920 \text{ kip-in}$$

Therefore, compression steel is needed to carry the difference.

$$A_{s1} = \rho_{\max} \times b \times d = 0.0158 \times 12 \times 20.5 = 3.88 \text{ in}^2$$

$$\text{The extra moment, } M_{u1} = M_u - M_{u1} = 4920 - 3515 = 1305 \text{ kip-in}$$

The additional tension and compression steel due to extra moment M_{u2}

$$\text{Assume, } d' = 2.5 \text{ in}$$

$$A_{s2} = \frac{M_{u2}}{\phi \times f_y \times (d - d')} = \frac{1305}{0.9 \times 60 \times (20.5 - 2.5)} = 1.34 \text{ in}^2$$

Total tension steel,

$$A_s = A_{s1} + A_{s2} = 3.88 + 1.34 = 5.22 \text{ in}^2$$

The compression steel has, $A_s' = 1.34 \text{ in}^2$

Choose Steel Bars As Follows

Tension Zone

$$\text{No. of steel using \#9 bar, } n = \frac{A_s}{A_b} = \frac{5.22}{1} = 5.22 \approx 6$$

$$\text{Use 6 bars of \#9; } A_{s,\text{prov.}} = 6 \text{ in}^2 > 5.22 \text{ in}^2 \quad (\text{ok})$$

Compression Zone

$$\text{No. of steel using \#9 bar, } n = \frac{A_s'}{A_b} = \frac{1.34}{1} = 1.34$$

$$\text{Use 3 bars of \#9; } A_{s',\text{prov.}} = 3 \text{ in}^2 > 1.34 \text{ in}^2 \quad (\text{ok})$$

Check If Compression Steel Yields:

$$\varepsilon_y = \frac{f_y}{29000} = \frac{60}{29000} = 0.00207$$

$$\text{Let, } a = \frac{A_{s1} \times f_y}{0.85 \times f'_c \times b} = \frac{3.88 \times 60}{0.85 \times 3.5 \times 12} = 6.52 \text{ in}$$

$$\text{Distance to neutral axis, } c = \frac{a}{\beta_1} = \frac{6.52}{0.85} = 7.67 \text{ in}$$

Strain in compression steel,

$$\varepsilon'_s = 0.003 \times \left(\frac{c - d'}{c} \right) = 0.003 \times \left(\frac{7.67 - 2.5}{7.67} \right) = 0.002022 < \varepsilon_y = 0.00207$$

Therefore, compression steel does not yield and $\phi = 0.65$

$$\rho_1 = \frac{A_{s1}}{bd} = \frac{3.88}{12 \times 20.5} = 0.0158$$

$$\frac{\rho_1}{\rho_b} = \frac{0.0158}{0.0249} = 0.6345$$

$$d_t = h - 2.5 = 24 - 2.5 = 21.5 \text{ in}$$

$$\text{At the lower row of bars, } \varepsilon_t = \left(\frac{d_t - c}{c} \right) \times 0.003 = \left(\frac{21.5 - 7.67}{7.67} \right) \times 0.003 = 0.0054 > 0.005$$

Tension controlled section; $\phi = 0.9$

Moment at mid span

$$M_u = 188 \times 12 = 2256 \text{ kip-in}$$

First check whether the beam as singly reinforced can carry the moment.

$$M_{u1} = 3615 \text{ kip-in} > M_u = 2256 \text{ kip-in}$$

So, design the beam as singly reinforcement beam.

Choose Steel Bars as Follows**Tension Zone**

$$\rho = \frac{0.85 f'_c}{f_y} \left[1 - \sqrt{1 - \frac{2M_u}{\phi 0.85 f'_c b d^2}} \right] = \frac{.85 \times 3.5}{60} \left[1 - \sqrt{1 - \frac{2 \times 2256}{.9 \times .85 \times 3.5 \times 12 \times 20.5^2}} \right] = 0.0091$$

$$A_s = \rho b d = 0.0091 \times 12 \times 20.5 = 2.24 \text{ in}^2$$

$$\text{No. of steel using \#9 bar, } n = \frac{A_s}{A_b} = \frac{2.24}{1} = 2.24 \approx 3$$

Use 3 bars of #9; $A_{s,prov.} = 3 \text{ in}^2 > 2.24 \text{ in}^2$ (ok)

Compression Zone

Use 2 bars of #9; $A_s'_{\text{prov.}} = 2 \text{ in}^2$

7.2.4 Seismic Design Check

Adequacy of beam flexural design for a special moment frame at section 1- 1:

a) Check limitation on material for the beam.

$$\text{i) } f_c' = 3500 \text{ psi} > 3000 \text{ psi} \quad (\text{ok})$$

$$\text{ii) } f_c' = 3500 \text{ psi} < 5000 \text{ psi} \quad (\text{ok})$$

$$\text{iii) } f_{yt} = 60000 \text{ psi} \leq 60000 \text{ psi} \quad (\text{ok})$$

b) Check geometric constraints for the beam.

$$\text{i) Clear span, } l_n = 26.67 \text{ ft} > 4d = 4 \times \frac{20.56}{12} = 6.85 \text{ ft}$$

$$\text{ii) } \frac{b_w}{h} = \frac{12}{24} = 0.5 > 0.3$$

$$\text{iii) } b_w = 12 \text{ in} > 10 \text{ in}$$

$$\text{iv) } b_w = 12 \text{ in} < C_2 = 18 \text{ in}$$

c) Check for minimum and maximum ratio of longitudinal reinforcement at section 1-1.

$$\text{i) } \rho_{\min} = \frac{200}{f_y} = \frac{200}{60000} = 0.0033$$

$$\text{ii) } 3\#9 \text{ bars result in } \rho' = \frac{A_s'}{bd} = \frac{3}{12 \times 20.56} = 0.012$$

iii) 6 #9 bars at top

$$\text{iv) Maximum } (\rho - \rho') = \frac{A_s}{bd} - \frac{A_s'}{bd} = \frac{6 \times 1}{12 \times 20.56} - \frac{3 \times 1}{12 \times 20.56} = 0.012 < \rho_{\max} = 0.016$$

d) Check for minimum positive and negative moment capacity at section 1-1.

$M_n^+ \geq 0.5M_n^-$ at column face.

$$k_n^- = 1.25 \times \rho \times f_y \times \left(1 - 0.735 \times \rho \times \frac{f_y}{f_c'} \right)$$

$$k_n^- = 1.25 \times 0.0249 \times 60000 \times \left(1 - 0.735 \times 0.0249 \times \frac{60000}{3500} \right) = 1282 \text{ psi}$$

$$M_n^- = \frac{k_n^- \times b \times d^2}{12000} = \frac{1282 \times 12 \times (20.56)^2}{12000} = 542 \text{ ft - kip}$$

$$k_n^+ = 1.25 \times \rho' \times f_y \times \left(1 - 0.735 \times \rho' \times \frac{f_y}{f_c'} \right)$$

$$k_n^+ = 1.25 \times 0.012 \times 60000 \times \left(1 - 0.735 \times 0.012 \times \frac{60000}{3500} \right) = 763 \text{ psi}$$

$$M_n^+ = \frac{k_n^+ \times b \times d^2}{12000} = \frac{763 \times 12 \times (20.56)^2}{12000} = 332 \text{ ft} \cdot \text{kip} > 0.5 \times 542 = 271 \text{ ft} \cdot \text{kip}$$

i) $M_n^+ \geq 0.25M_{n \max}^-$ at section 1-1

$$M_n^+ = 332 \text{ ft} \cdot \text{kip} > 0.25 \times 542 = 135.5 \text{ ft} \cdot \text{kip}$$

ii) $M_n^- \geq 0.25M_{n \max}^-$ at section 1-1

$$M_n^- = 542 \text{ ft} \cdot \text{kip} > 0.25 \times 405 = 101 \text{ ft} \cdot \text{kip}$$

Midsection:

Adequacy of beam flexural design for a special moment frame at section 2-2

a) Check geometric constraints for the beam.

i) Clear span, $l_n = 26.67 \text{ ft} > 4d = 4 \times \frac{20.56}{12} = 6.85 \text{ ft}$

ii) $\frac{b_w}{h} = \frac{12}{24} = 0.5 > 0.3$

iii) $b_w = 12 \text{ in} > 10 \text{ in}$

iv) $b_w = 12 \text{ in} < C_2 = 18 \text{ in}$

b) Check for minimum and maximum ratio of longitudinal reinforcement at section 2-2.

i) $\rho_{\min} = \frac{200}{f_y} = \frac{200}{60000} = 0.0033$

ii) 2#9 bars result in $\rho' = \frac{A_s'}{bd} = \frac{2}{12 \times 20.56} = 0.0081$

iii) 3#9 top and bottom continuous bars.

iv) Maximum $(\rho - \rho') = \frac{A_s}{bd} - \frac{A_s'}{bd} = \frac{3 \times 1}{12 \times 20.56} - \frac{2 \times 1}{12 \times 20.56} = 0.0040 < \rho_{\max} = 0.016$

c) Check for minimum positive and negative moment capacity at section 2-2.

i) $M_n^+ \geq 0.5M_n^-$ at column face.

$$k_n^- = 1.25 \times \rho \times f_y \times \left(1 - 0.735 \times \rho \times \frac{f_y}{f'_c} \right)$$

$$k_n^- = 1.25 \times 0.0249 \times 60000 \times \left(1 - 0.735 \times 0.0249 \times \frac{60000}{3500} \right) = 1281 \text{ psi}$$

$$M_n^- = \frac{k_n^- \times b \times d^2}{12000} = \frac{1281 \times 12 \times (14.56)^2}{12000} = 271 \text{ ft - kip}$$

$$k_n^+ = 1.25 \times \rho' \times f_y \times \left(1 - 0.735 \times \rho' \times \frac{f_y}{f'_c} \right)$$

$$k_n^+ = 1.25 \times 0.0040 \times 60000 \times \left(1 - 0.735 \times 0.0040 \times \frac{60000}{3500} \right) = 284 \text{ psi}$$

$$M_n^+ = \frac{k_n^+ \times b \times d^2}{12000} = \frac{284 \times 12 \times (20.56)^2}{12000} = 120 \text{ ft - kip} < 0.5 \times 271 = 135 \text{ ft - kip}$$

ii) $M_n^+ \geq 0.25 M_{n \max}^-$ at section 2 - 2

$$M_n^+ = 120 \text{ ft - kip} > 0.25 \times 271 = 67 \text{ ft - kip}$$

iii) $M_n^- \geq 0.25 M_{n \max}^-$ at section 2 - 2

$$M_n^- = 271 \text{ ft - kip} > 0.25 \times 120 = 30 \text{ ft - kip}$$

7.2.5 Design of seismic hooks

Critical end regions of abeam in a special moment frame for shear and confinement.

$$DL = 4.2 \text{ kip/ft}$$

$$LL = 0.5 \text{ kip/ft}$$

$$w_u = 1.2D + 1.0L + 0.25S = 1.2 \times 4.2 + 1.0 \times 0.5 + 0 = 5.54 \text{ kip/ft}$$

Taken from etabs, $V_{\max} = 65.16 \text{ kip}$

$$V_e = \frac{M_n^+ + M_n^-}{l_n} \pm \frac{w_u \times l_n}{2} = \frac{332 + 542}{26.67} \pm \frac{5.54 \times 26.67}{2} = 106 \text{ kip or } 41 \text{ kip}$$

$$\frac{V_{\max}}{2} = \frac{65.16}{2} = 32 \text{ kip} < V_e$$

Assuming #4 Perimeter hooks

$$V_s = \frac{V_e}{\phi} = \frac{106}{0.75} = 141 \text{ kip}$$

$$S_{cr} = \frac{A_v \times f_y \times d}{V_s} = \frac{3 \times 0.20 \times 60 \times 20.56}{141} = 5.25 \text{ in} \approx 5 \text{ in}$$

$$S_{cr} \leq \frac{d}{4} = \frac{20.56}{4} = 5.14 \approx 5 \text{ in} ;$$

$$S_{cr} \leq 8 \times d_{b \text{ long}} = 8 \times 1.128 = 9 \text{ in} ;$$

$$S_{cr} \leq 24 \times d_{b\text{hoop}} = 24 \times 0.375 = 9 \text{ in ;}$$

$$S_{cr} \leq 12 \text{ in}$$

$$\therefore S_{cr} = S_1 = 5 \text{ in}$$

Provide, $S_1 = 5 \text{ in}$ within $2h = 2 \times 24 = 48 \text{ in} = 4 \text{ ft}$

$$S_2 \leq \frac{d}{2} = \frac{20.56}{2} = 10.28 \text{ in}$$

$$\therefore S_2 = 12 \text{ in}$$

Hooks should extend $6d_b = 6 \times 1 = 6 \text{ in}$ or 3 in

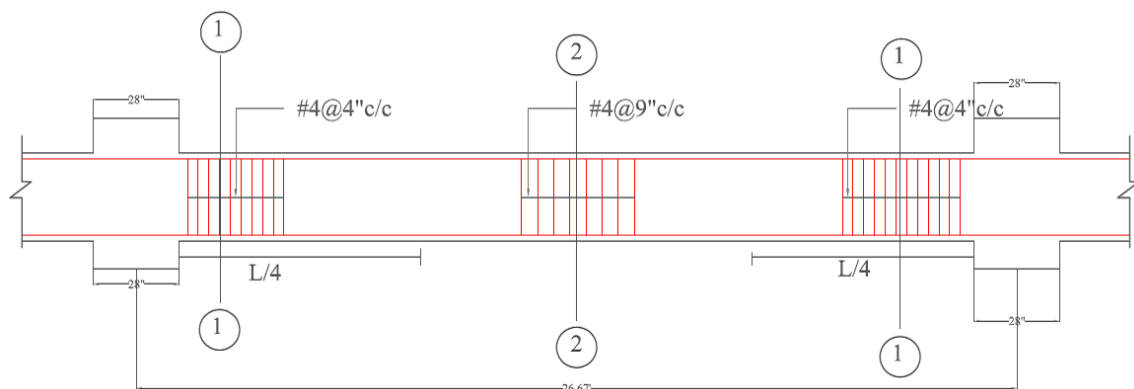

Figure 7.3: Details Reinforcement of Interior Beam

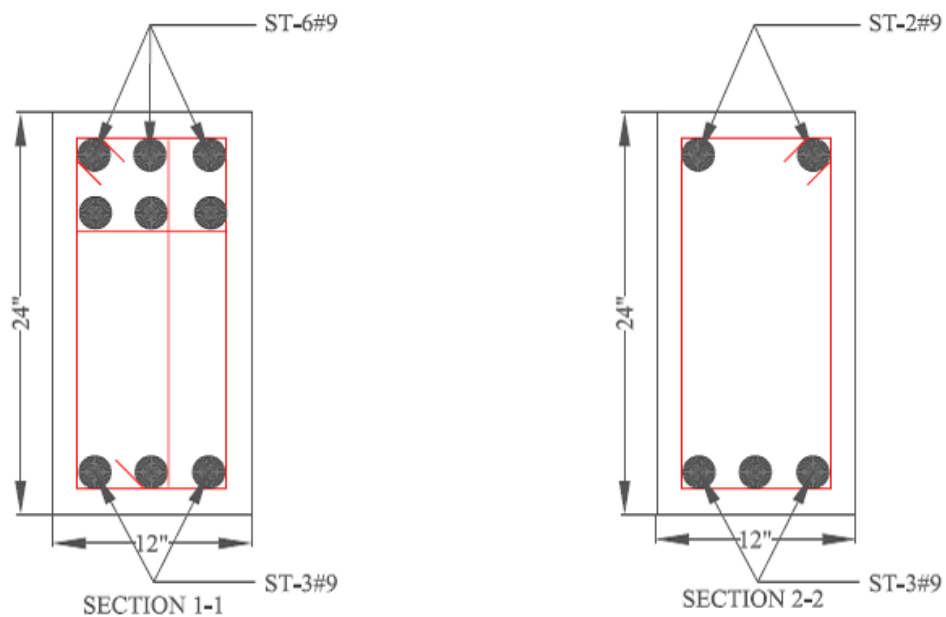

Figure 7.3: Details Reinforcement of Interior Beam

CHAPTER 8

DESIGN OF COLUMN

8.1 Introduction

The column dimension has been established as C1= 28in × 32in and C2= 24in x 32in on the basis of the different combinations of axial load and bending moment. Using concrete material of ultimate strength, $f'_c = 3500$ psi and reinforcement bars for both longitudinal reinforcement and ties of strength, $f_y = 60,000$ psi. Column layout plan is shown in Figure 8.1.

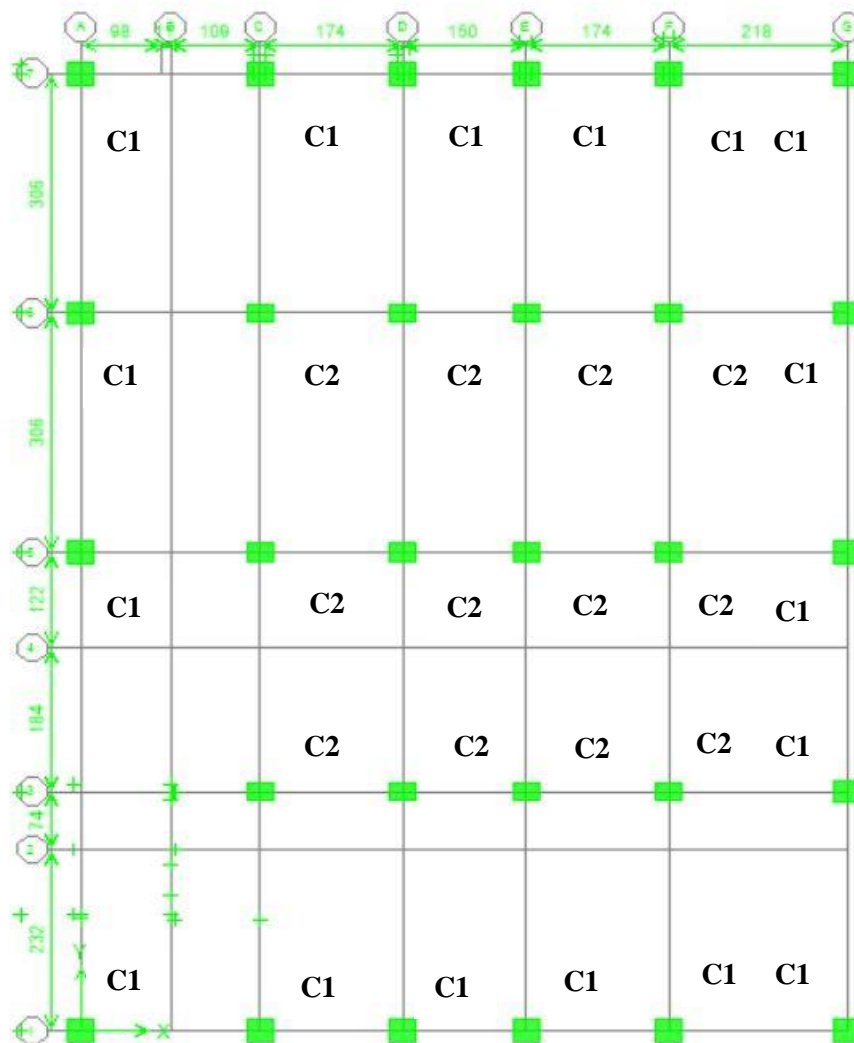

Figure 8.1: Column layout plan

8.2 Design of column C-1

Reinforcement calculation:

Axial force and bending moment diagram taken from ETABS analysis result file are shown in Figures 8.2 and 8.3.



Figure 8.2: Maximum Axial force diagram of column C1 of grid 7-7 (kip)

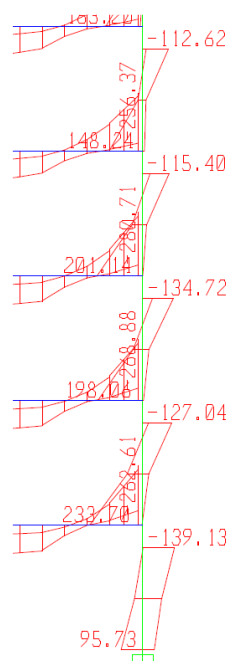

Figure 8.3: Maximum Bending moment diagram of column C1 of grid 7-7 (kip – ft)

For column bending one-axis

Maximum axial force on column C_1 , $P_u = 2308.01$ kips

Check the level of axial compression:

$$A_g f'_c / 10 = (896 \times 3500) / (10 \times 1000) = 313.6 \text{ kips}$$

$\phi P_n = 2564 \text{ kips} > 313.6 \text{ kips}$. Therefore, the requirements of section 21.4.4 of ACI318-05 apply.

Total moment on column C_1 at joint M_u ,

= Lower column moment + Upper column moment

$$= 127.04 + 233.10$$

$$= 360.14 \text{ kip-ft}$$

$$= 4321.68 \text{ kip-in}$$

$$\gamma_h = 32 - 2 \times 1.5 - 2 \times 0.2 - 9/8 = 27.475$$

$$\gamma = 27.475/h = 27.475/32 = 0.86$$

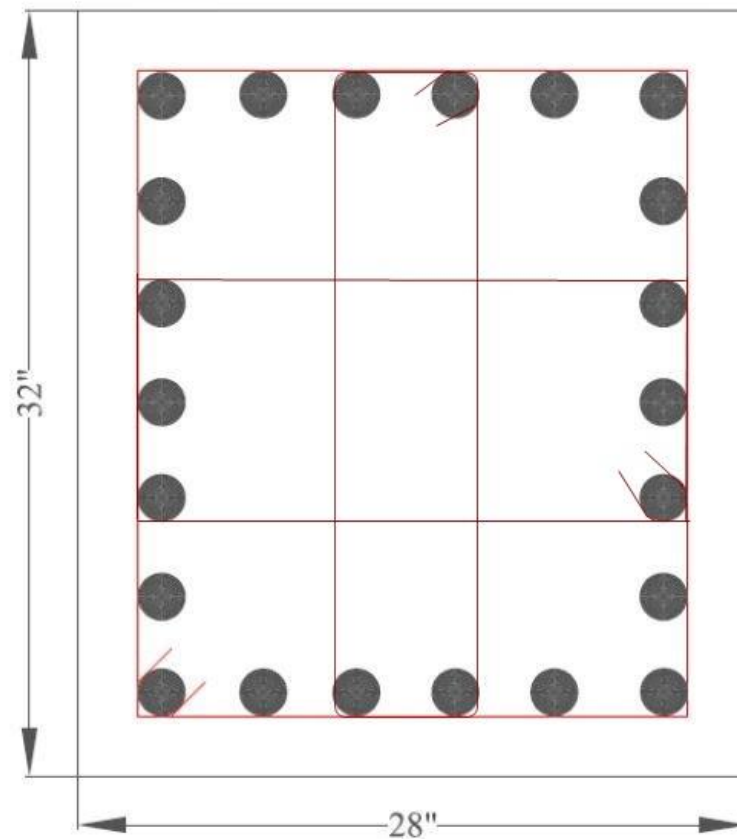

Figure 8.4: Sectional diagram of column C_1

$$K_n = \frac{P_u}{\phi \times f'_c \times A_g} = \frac{2308.1}{0.75 \times 3.5 \times 32 \times 28} = 1.02$$

$$R_n = \frac{Mu}{\phi \times f'_c \times A_g \times h} = \frac{4321.68}{0.75 \times 3.5 \times 32 \times 28 \times 32} = 0.07$$

From the strength interaction diagram, $\rho_g = 0.015 > 0.01$

$$P_u = \phi A_g [0.85 \times f'_c \times (1 - \rho_g) + \rho_g \times f_y]$$

Or, $2308.01 = 0.75 \times 0.80 \times A_g \times [0.85 \times 3.5(1 - 0.035) + 0.035 \times 60]$

$$A_g = 892.8 \text{ in}^2 < 856 \text{ in}^2 \quad (\text{ok})$$

The selected column size was 32 in \times 28 in

$$\text{So, } A_{st} = \rho_g \times A_g = 0.035 \times 32 \times 28 = 31.36 \text{ in}^2$$

Use 22 bars of #11

8.2.1 Design of Tie Bar of Column for a Special Moment Resisting Frame

Seismic tie design:

Column height = 11 ft.

Spacing:

$$S_{cr} = \frac{\text{Least dimension of column}}{4} = \frac{28}{4} = 7''$$

$$S_{cr} = 6 \times d_{main} = 6 \times 1.41 = 8.46''$$

$$S_o = 4 + \frac{14 - h_x}{3} = 4 + \frac{14 - 0}{3} = 8.67 \text{ in}$$

So, use $S_{cr} = 6 \text{ in}$

Length over seismic ties are required:

$$l_o = \text{Depth of column} = 32''$$

$$l_o = \frac{\text{Clear span of column}}{6} = \frac{11}{6} \times 12 = 22''$$

$$l_o = 20''$$

Provide, $l_o = 32 \text{ in}$.

Use #3 seismic ties @6 in c/c up to length 2'-8" from both beam faces.

Define S_{max} :

$$S_{max} = 6 \text{ in}$$

$$S_{max} = 6d_b = 6 \times 1.41 = 8.46 \text{ in}$$

Use $S_{max} = 6 \text{ in}$

Lapping tie design:

Spacing:

$$S_{sp} = d/4 = (28-3)/4 = 6.25 \text{ in}$$

$$S_{sp} = 4 \text{ in}$$

Use #3 bars @ 4 in c/c at splicing.

Length:

If required, splicing should be given near the mid column length.

$$\text{Now, Splice length} = 1.3 \times l_d$$

For #9 main bars, development length, l_d

$$l_d = 0.04 \times A_b \times \frac{f_y}{\sqrt{f'_c}} = 0.04 \times 1.41 \times \frac{60000}{\sqrt{3500}} = 57''$$

$$l_d = 0.0004 \times d_b \times f_y = 0.0004 \times 1.41 \times 60000 = 33.84''$$

$$l_d = 12'' \text{ (Minimum requirement)}$$

Maximum length should be selected. So, $l_d = 57 \text{ in}$

$$\therefore \text{Lapping length} = 1.30 \times 57'' = 74.1''$$

Use #3 lapping tie @4 in c/c up to 6'-2" length.

Spacing of the bars:

$$S_1 = \frac{32 - 2(1.5 + 0.375) - 7 \times 1.41}{6} = 3.0 \text{ in} \text{ So, No additional ties are required.}$$

$$S_2 = \frac{28 - 2(1.5 + 0.375) - 6 \times 1.41}{5} = 3.0 \text{ in} \text{ So, No additional ties are required.}$$

Table No: 8.1 Detail of sectional dimension and reinforcement arrangement of column C1

Section name	Height of section (ft)	Section Size (in × in)	Area (in ²)	Steel Ratio (ρ)	Bar
Section 1-1	0'-40'	32×28	896	0.035	22#11
Section 2-2	45'-88'	30×26	780	0.035	18#11
Section 3-3	89'-132'	28×24	672	0.035	16#11

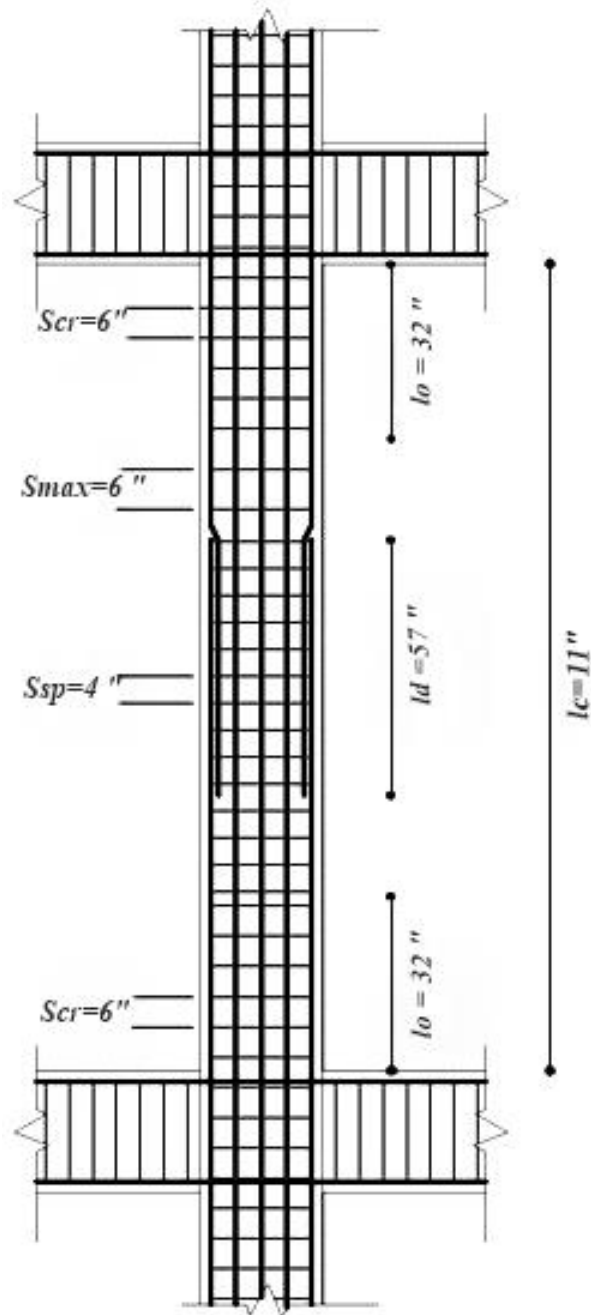

Figure 8.5: Distribution of seismic ties in column C₁

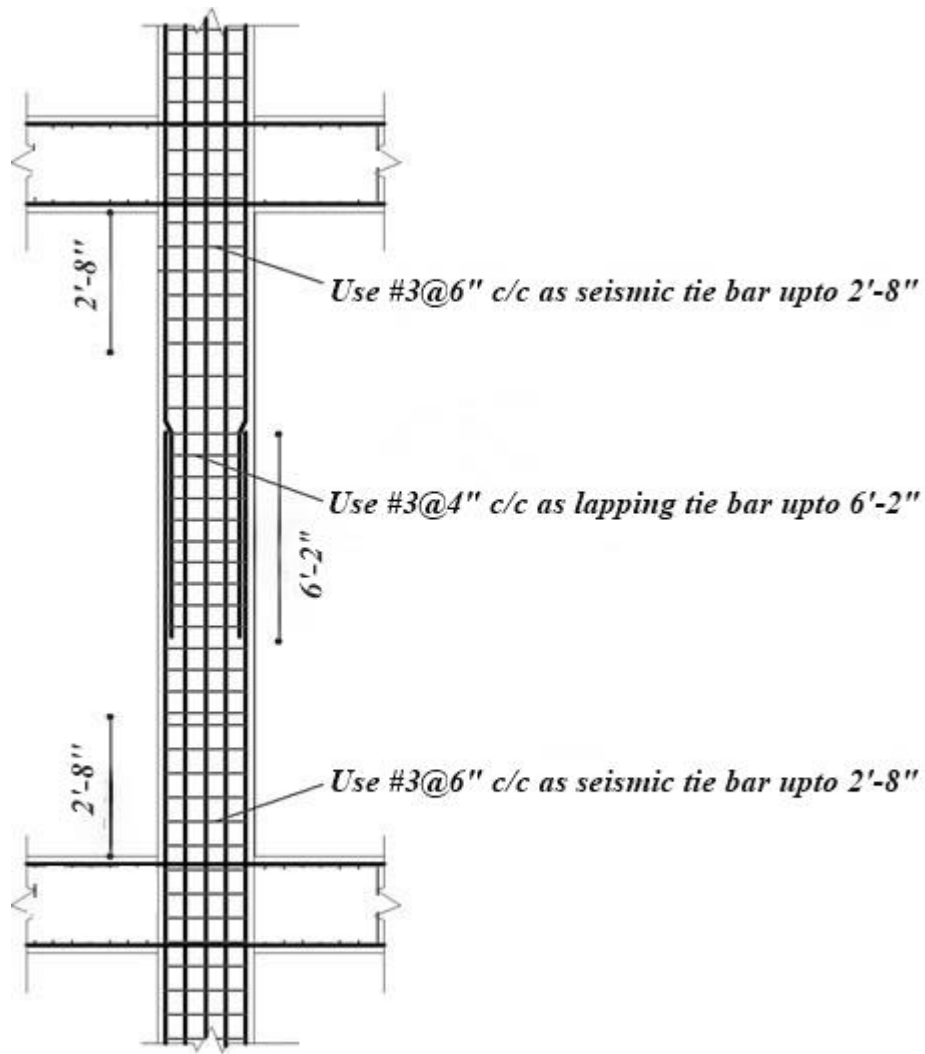

Figure 8.6: Longitudinal Cross-section of column C₁

CHAPTER 9

DESIGN OF STAIR

9.1 Introduction

Depending on the type of the floors there are different types of stairs. The stair for emergency exit starts from the base floor to the ceiling of 10th floor.

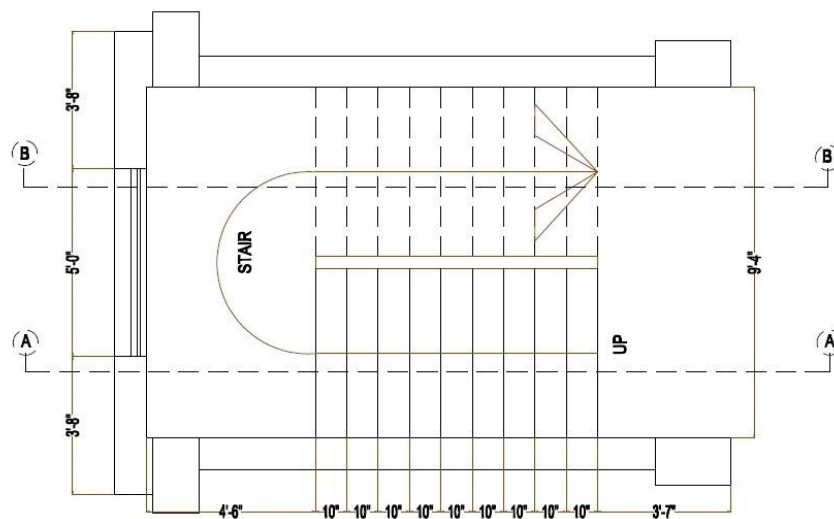

Figure 9.1: Plan view of stair case

9.2 Design of Staircase

Design data:

Landing = 4.5ft

Width of the steps = 4.5 ft

Flight = 7.5ft

Rise = 6 in

Tread = 10 in

$f_y = 60$ ksi

$f_c' = 3.5$ ksi

Design of flight:

Effective length = Flight + Landing`

$$= (12 + 10 \times 9 + 54 + 6) / 12 = 13.5\text{ft}$$

$$\text{Minimum thickness of waist slab, } t = \frac{L}{28} = \frac{13.5 \times 12}{28} = 5.78\text{in} \approx 6\text{in}$$

$$\text{Self-weight of waist slab} = \frac{6}{12} \times 150 = 75\text{psf}$$

$$\text{Self-weight of Steps} = \left(\frac{1}{2} \times \frac{10}{12} \times \frac{6}{12} \times 150 \right) \div \frac{10}{12} = 37.5\text{psf}$$

Floor finish = 40 psf

Total dead load = 75+37.5+40

$$= 152.5\text{psf}$$

Live load = 100psf

$W_u = 1.2\text{DL} + 1.6\text{LL}$

$$= 1.2 \times 152.5 + 1.6 \times 100$$

$$= 343\text{psf}$$

Bending moment calculation:

$$= \frac{W_u L^2}{8} = \frac{343 \times 13.5^2}{12} = 7813.96\text{lb-ft} = 93.76\text{k-in}$$

$$p_{max} = 0.75\text{pb}$$

$$= 0.75 \times 0.85 \beta_1 \times \frac{f'_c}{f_y} \times \frac{87000}{87000 + f_y}$$

$$= 0.75 \times 0.85 \times 0.85 \times \frac{3.5}{60} \times \frac{87000}{87000 + 60} = 0.0187$$

$$d = \sqrt{\frac{M_u}{pf_y \left(1 - 0.59 \frac{pf_y}{f'_c} \right)}}$$

$$= \sqrt{\frac{93.76}{0.90 \times 0.0187 \times 60 \times 12 \left(1 - 0.59 \frac{0.0187 \times 60}{3.5}\right)}}$$

$$= 3.08 \text{ in} < 5 \text{ in (ok)}$$

Reinforcement calculation:

$$\rho = \frac{0.85 f'_c}{f_y} \left[1 - \sqrt{1 - \frac{2M_u}{0.85 \phi f'_c b d^2}} \right]$$

$$\rho = \frac{0.85 \times 3.5}{60} \left[1 - \sqrt{1 - \frac{2 \times 93.76}{0.85 \times 0.9 \times 3.5 \times 12 \times 5^2}} \right] = 0.0062$$

$$A_{st} = \rho b d = 0.0062 \times 12 \times 5 = 0.372 \text{ in}^2$$

$$\text{Use \#4 bar, Spacing } \frac{A_b}{A_{st}} = \frac{0.2 \times 12}{0.372} = 6.45 \text{ in} \cong 6 \text{ in}$$

Use #4bar@ 6.0in c/c at mid span and will be continued up to both supports.

Temperature steel calculation:

$$A_{st \text{ min}} = \rho b h$$

$$= 0.0018 \times 12 \times 6$$

$$= 0.13 \text{ in}^2/\text{ft}$$

$$\text{Use \#3 bar, Spacing} = \frac{0.11 \times 12}{0.13}$$

$$= 10.15 \text{ in} \cong 10 \text{ in} < 3h = 3 \times 5 = 15 \text{ in}$$

Use #3 bar@ 10in c/c as binder perpendicular to main reinforcement

.

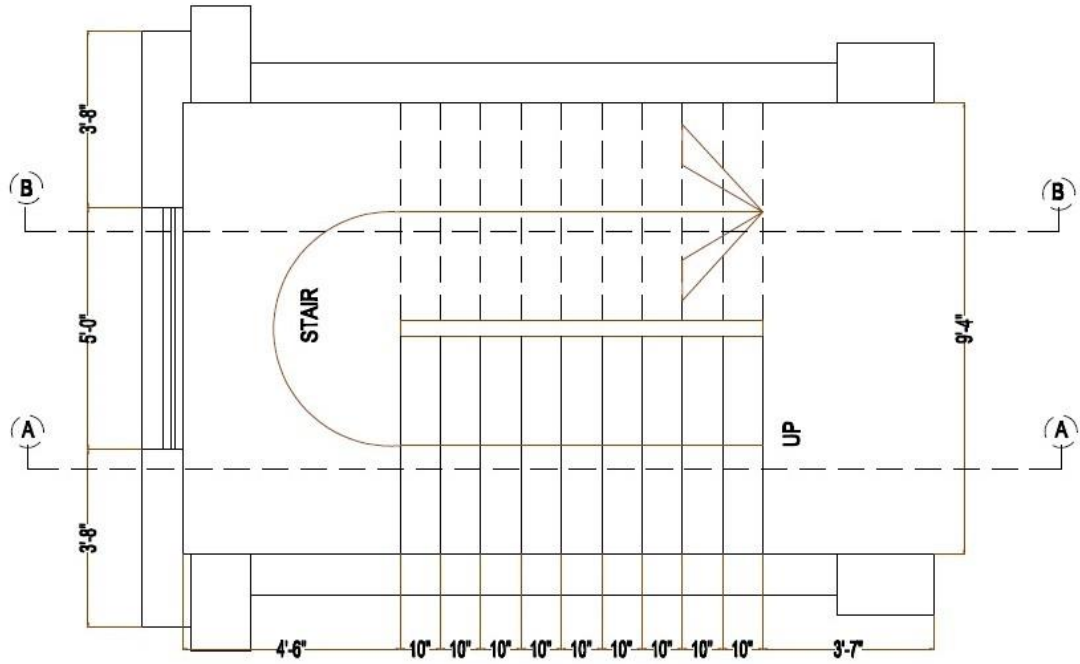

Figure 9.2: Plan view of stair

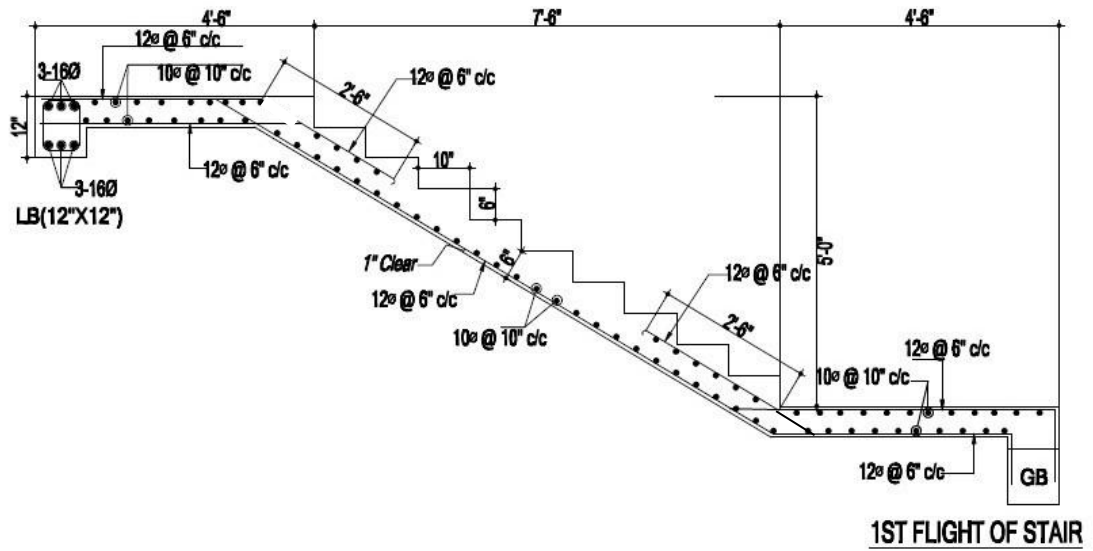

Figure 9.3: Reinforcement details of stair section A-A

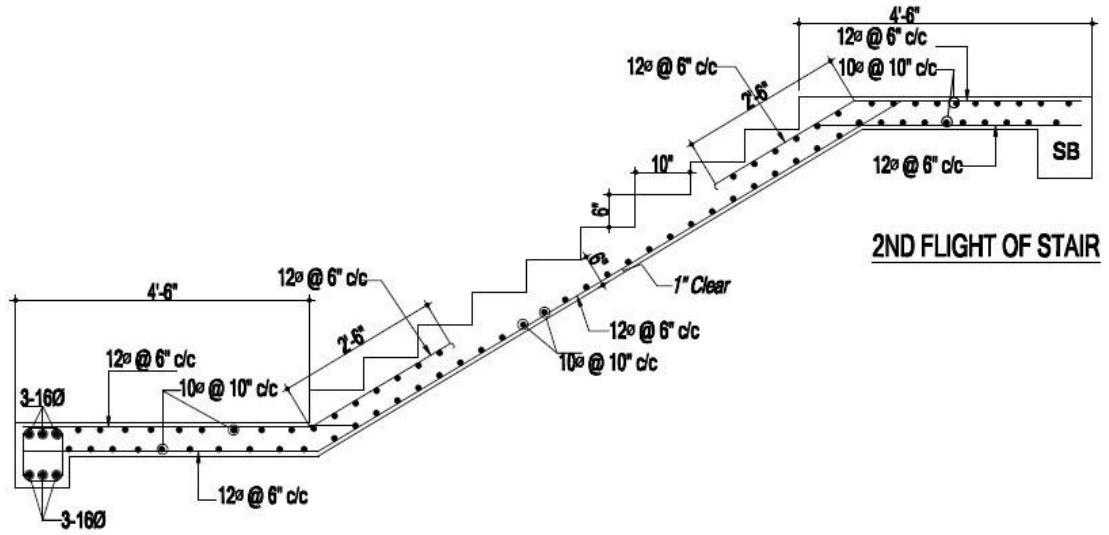

Figure 9.4: Reinforcement details of stair section B-B

CHAPTER 10

DESIGN OF SHEAR WALL

10.1 Introduction

The shear wall surrounding the shear wall is 10in thick concrete wall, and computer analysis is done by the software ETABS as per ACI code.

10.2 Design of shear wall

Design data

$$f_y = 60000 \text{ psi}$$

$$f'_c = 3500 \text{ psi}$$

$$W_c = 150 \text{ pcf}$$

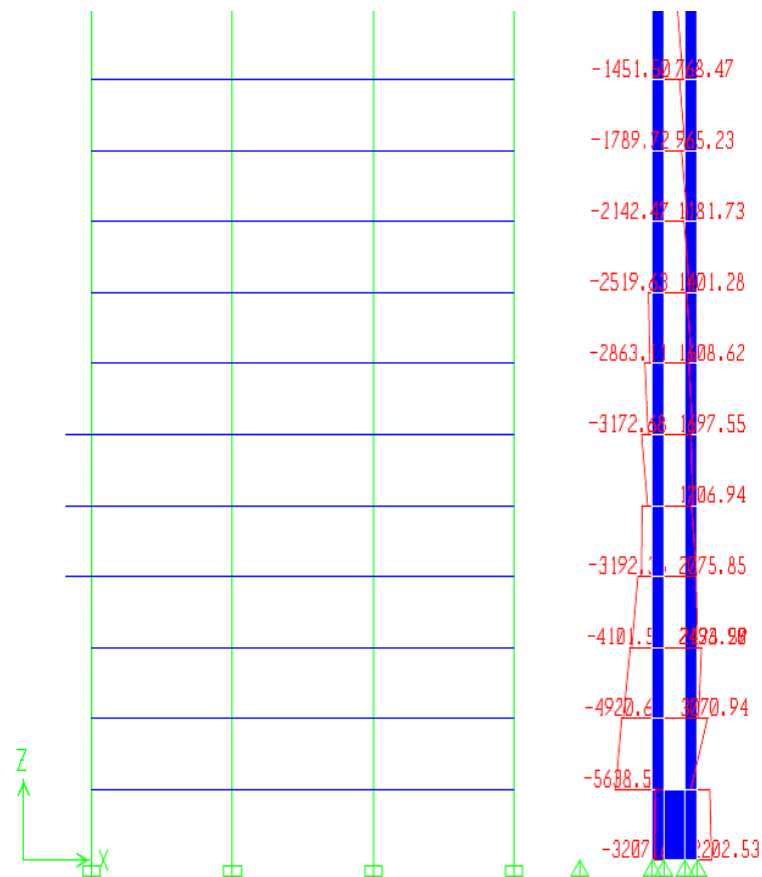

Figure 10.1: Bending moment for shear wall grid B-B (kip-ft)

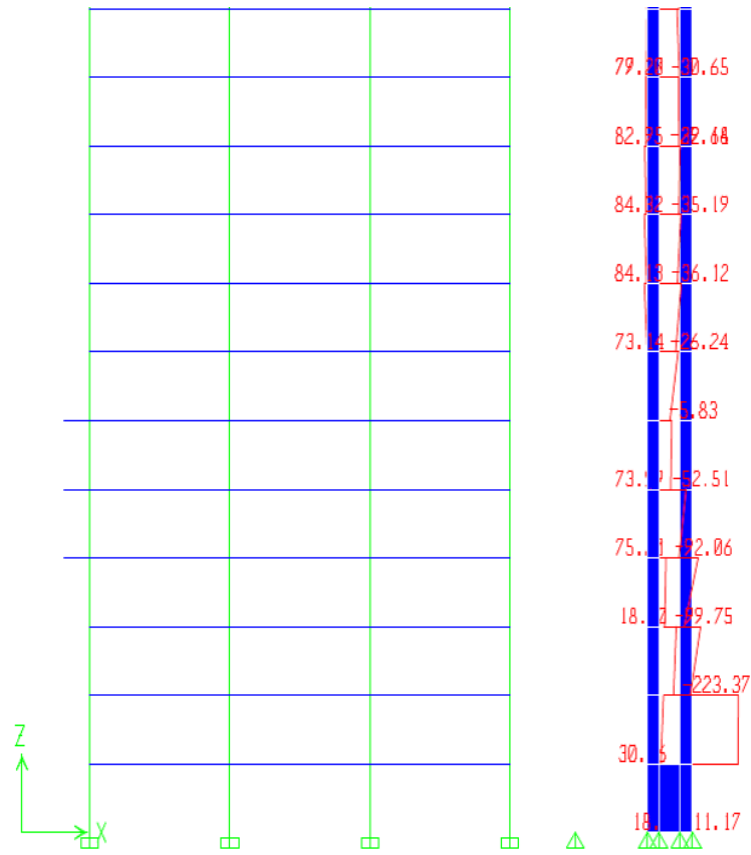

Figure 10.2: Shear for shear wall grid B-B (kip)

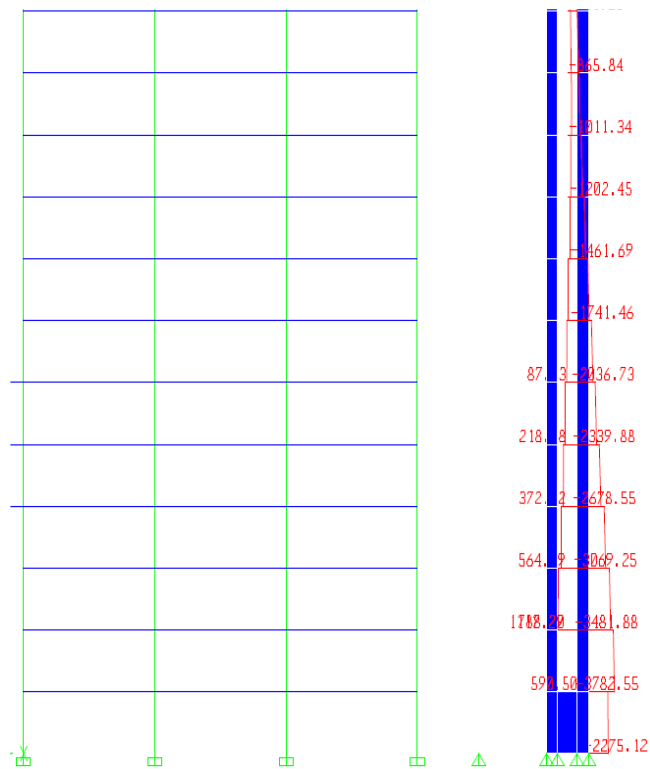

Figure 10.3: Axial force for shear wall grid B-B (kip)

Design data from ETABS Analysis

Moment (M_u) = 5638.37 k-ft

Shear force (V_u) = 223.37kip

Axial force (P_u) = 3782.55 kip

Design Dimension:

Length of shear wall, $L_w=12.3$ ft

Width of shear wall, $b_w= 10$ in

Height of shear wall, $h_w= 132$ ft

Checking requirement of the boundary element:

$$\text{Moment of inertia } I_g = \frac{b_w \times l_w^3}{12} = \frac{10 \times (12.3 \times 12)^3}{12} = 2679648 \text{ in}^4$$

$$\begin{aligned} \text{Stress } f_c &= \frac{P_u}{A} \pm \frac{Mc}{I_g} = \frac{3782.55 \times 1000}{2 \times 10 \times 12.3 \times 12} + \frac{5638.57 \times 12 \times 1000 \times 12.3 \times 12}{2 \times 2679648} \\ &= 1281 + 1863 = 3144 \text{ psi} \end{aligned}$$

Permissible stress $0.20 \times f'_c = 0.20 \times 3500 = 700$ psi

According to the ACI code, since $f_c > (0.20 \times f'_c)$, so the boundary elements are required.

Dimension of the boundary element:

Thickness of the boundary element, $b_b = 10$ "

Length of the boundary element, $l_b = 0.25l_w = 0.25 \times 12.3 = 3.075' = 37$ "

Minimum b_b or l_b will be equal or larger of the followings:

$$\text{i) } \frac{l_w}{16} = \frac{12.3 \times 12}{16} = 9.22''$$

$$\text{ii) } 18''$$

So, provide $10'' \times 37''$ boundary element.

Requirement of longitudinal & transverse reinforcements:

According to the ACI code,

$$\text{Shear strength of concrete} = \frac{A_{cv} \times \sqrt{f'_c}}{6}$$

$$= \frac{12.3 \times 10 \times 12 \times \sqrt{3500}}{6 \times 1000} = 14.55 \text{kip} < V_u = 223.37 \text{kip}$$

Also, $b_w = 10'' = 10''$ (ok)

So, two sets of reinforcement curtains will be required.

10.2.1 Calculation of longitudinal & transverse reinforcements:

Longitudinal & transverse reinforcement ratios will be, $\rho_v = 0.0025$ and $\rho_h = 0.0025$.

Total longitudinal reinforcement per feet of wall, $A_{sv} = 0.0025 \times 10 \times 12 = 0.3 \text{ in}^2/\text{ft}$

Total transverse reinforcement per feet of wall, $A_{sh} = 0.0025 \times 10 \times 12 = 0.3 \text{ in}^2/\text{ft}$

Use #5 bars and required spacing [in two curtains, $A_v = 2(0.2) = 0.4 \text{ in}^2/\text{ft}$

$$S = \frac{0.4 \times 12}{0.3} = 16'' \text{ c/c in both directions.}$$

According to the ACI code, maximum spacing will be smaller of the followings:

$$S_{\max} = 3h = 3 \times 10 = 30'' \text{ c/c}$$

$$S_{\max} = \frac{l_w}{5} = \frac{12.3 \times 12}{5} = 29.52'' = 29.5'' \text{ c/c}$$

So, $S_{\max} = 16'' \text{ c/c}$ is selected and provide #4 bars @ 16'' in both directions.

Check shear strength of concrete of wall to resist V_u :

$$h_w/l_w = \frac{132}{12.3} = 10.73 > 2.0$$

Shear strength of concrete with two sets of #4 bars will be,

$$\begin{aligned} \phi V_n &= \phi A_{cv} \left(2\sqrt{f'_c} + \rho_n f_y \right) \\ &= 0.60 \times (10 \times 12.3 \times 12) \left[2 \times \sqrt{3500} + \frac{4 \times 0.2}{12 \times 12} \times 60000 \right] \times \frac{1}{1000} \\ &= 399.99 \text{ kip} > V_u = 223.37 \text{ kip} \end{aligned} \quad (\text{ok})$$

$$A_{s,prov.} = \frac{12}{2} = 6'' \text{ c/c}$$

Use #4 bars @ 6'' c/c as shear (horizontal) reinforcement.

Reinforcement for boundary elements:

$$A_g = 2 \times (10 \times 37) = 740 \text{ in}^2$$

$$R_n = \frac{M_u}{\phi_c' A_g h} = \frac{5638.57 \times 12}{2 \times 0.65 \times 3.5 \times 740 \times 12.3 \times 12} = 0.13$$

$$K_n = \frac{P_u}{\phi_c' A_g} = \frac{3782.55}{2 \times 0.65 \times 3.5 \times 740} = 1.1$$

$$\gamma = \frac{37 - 3}{37} = 0.91$$

From interaction diagrams, corresponding R_n & K_n value, reinforcement ratio, $\rho = 0.040$.

Total reinforcement required for the shear wall,

$$A_s = 0.040 \times 740 = 29.6 \text{ in}^2$$

Therefore reinforcement required for boundary element.

$$\text{For each boundary element, use} = \frac{29.6}{2} = 14.8 \text{ in}^2$$

Use 15#9 bars and provided steel area = 15 in^2 .

Minimum A_v should be larger of the followings:

$$A_v > \begin{cases} 0.005 \times \text{area of the boundary zone} \\ 2\#5 \text{ bars at each edge of the boundary zone} \end{cases}$$

So minimum $A_v = 0.005 \times 740 = 3.7 \text{ in}^2 < 15 \text{ in}^2$ (ok).

Design of Transverse reinforcement for boundary elements:**Spacing**

Transverse reinforcement spacing will be the smaller of the followings:

First condition

$$S_o = \text{minimum dimension of wall} / 4 = 10 / 4 = 2.5" \text{ c/c}$$

Second condition

$$S_o = 6d_b = 6 \times 1.125 = 6.75" = 6.5" \text{ c/c}$$

Third condition

$$S_x = \frac{14 - h_x}{3} + 4 = \frac{14 - 5}{3} + 4 = 7" \text{ c/c}$$

Since $6.5" \leq S_x \leq 7"$, so $S_x = 7"$

From above condition, the minimum spacing, $S_o = 3.0" \text{ c/c}$

The details of reinforcement arrangement are shown:

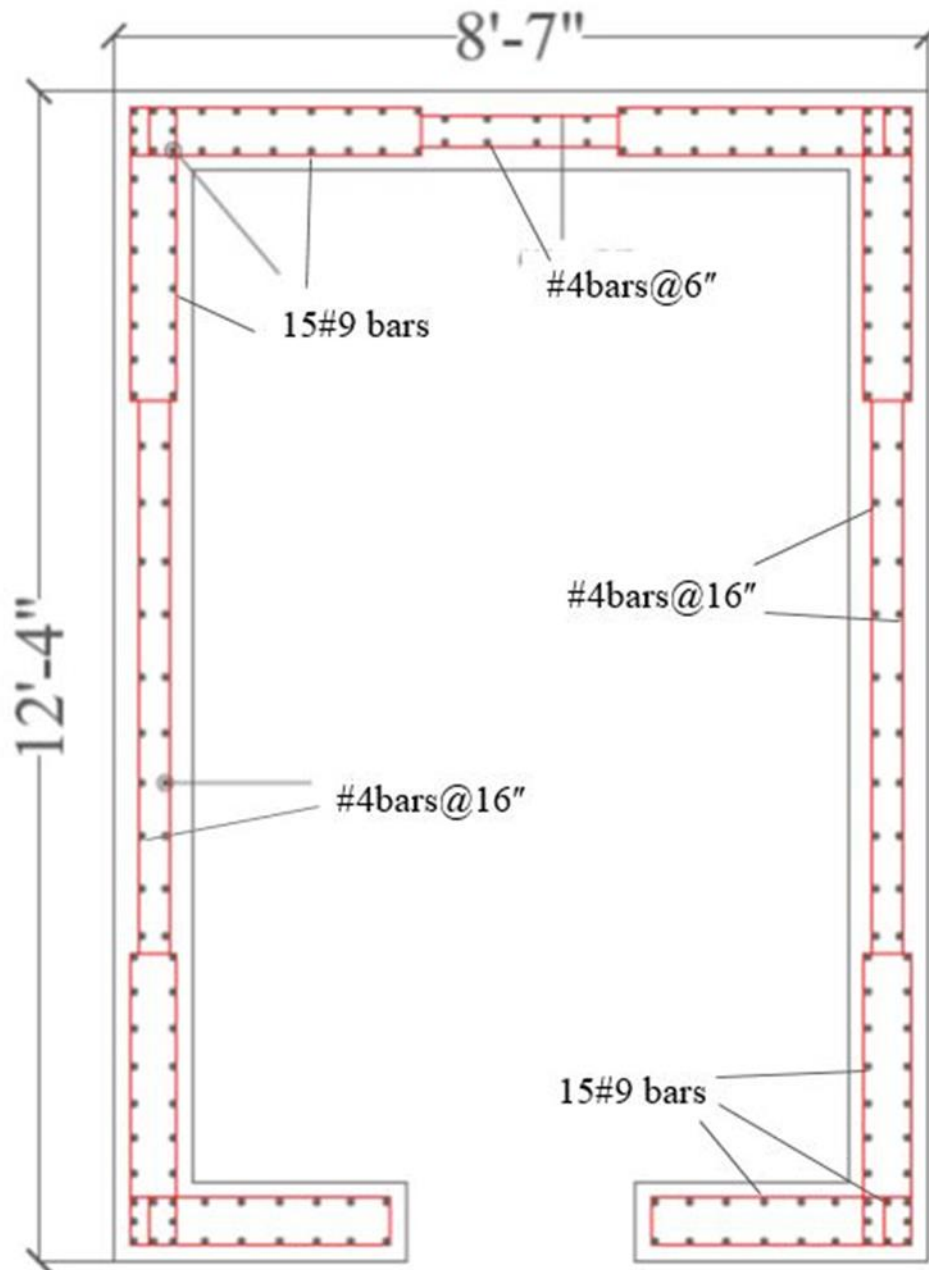

Figure 10.4: Reinforcement and cross-sectional details of shear wall

CHAPTER 11

DESIGN OF WATER RESERVOIR

11.1 Introduction

To fulfill the water demand of the commercial, residential and other purposes, there are two underground water reservoirs with the dimension of 20×30 ft each .

11.2 Determination of water consumption

Water requirement for hospital purpose:

Water required = 235 lpcd (BNBC)

No. of floor = 12

No. of person = 60 (Assume, each floor)

Total volume of water = $235 \times 60 \times 12 = 169200$ L

Garage purposes:

Water required = 235 lpcd

No. of floor = 2

No. of person = 40 (Assume, each floor)

Total volume of water = $235 \times 2 \times 40 = 18800$ L

Water requirement for firefighting:

Water required = 1000 L/min

Firefighting duration = 60 min

Total volume of water = $1000 \times 60 = 60,000$ L

Water requirement for commercial apartment:

Per capacity consumption = 235 lpcd (BNBC)

Assume, 115 person per commercial apartment

Number of apartment = 1

Capacity = $1 \times 115 \times 235 = 27025$ L

$$\begin{aligned} \text{Total water required for entire structures} &= (169200 + 18800 + 60000 + 27025) \\ &= 275025 \text{ L} \\ &= 9711.33 \text{ ft}^3 \end{aligned}$$

$$\text{Two reservoirs, each reservoir volume} = \frac{9711.33}{2} = 4855.66 \text{ cft}$$

$$B = 20 \text{ ft}$$

$$L = 30 \text{ ft}$$

$$\text{Hence, } H = \frac{4855.66}{30 \times 20} = 8.1 \text{ ft} \approx 8.0 \text{ ft}$$

$$\text{Free board} = 6 \text{ in} = 0.5 \text{ ft}$$

$$\text{So, total height} = 0.5 + 8.0 = 8.5 \text{ ft}$$

11.2.1 Design of base slab:

$$\text{Under water pressure} = \left(8.5 + \frac{10}{12}\right) \times \gamma_w = 9.33 \times 62.5 = 583.33 \text{ psf}$$

$$\text{Weight of base slab} = 10 \times 20 \times 30 \times \frac{150}{12} = 75000 \text{ lb/ft}$$

$$\text{Weight of cover slab} = \frac{6}{12} \times 20 \times 30 \times 150 = 45000 \text{ lb/ft}$$

$$\text{Weight of side wall} = \frac{6}{12} \times 8.5 \times 150 \times 2(21 + 31) = 66300 \text{ l/ft}$$

$$\text{Total weight} = 66300 + 45000 + 75000 = 186300 \frac{\text{lb}}{\text{ft}} = \frac{186300}{20 \times 30} = 310.5 \text{ psf}$$

$$\text{psf on slab} = 310.5 + 583.33 = 893.83 \text{ psf}$$

$$\text{Weight upward force on base} = 1.4 \times 583.33 - 1.4 \times 310.5 = 381.96 \text{ psf}$$

$$M_a = 0.095 \times 381.96 \times 20^2 = 14514.48 \text{ lb-ft}$$

$$M_b = 0.006 \times 381.96 \times 30^2 = 2062.58 \text{ lb-ft}$$

$$M_u = 14514.48 + 2062.58 = 16577.064 \text{ lb-ft}$$

$$d = \sqrt{\frac{M_u}{\phi f_y \rho b \left(1 - 0.59 \frac{\rho f_y}{f'_c}\right)}}$$

$$= \sqrt{\frac{16577.064 \times 12}{0.90 \times 60000 \times 0.0160 \times 12 \left(1 - 0.59 \frac{0.0160 \times 60000}{3500} \right)}}$$

$$= 4.78 \approx 5 \text{ in} < 10 \text{ in} \quad (\text{ok})$$

Steel Calculation:

For M_A

$$\rho = \frac{0.85 \times f'_c}{f_y} \left(1 - \sqrt{\left(1 - \frac{2M_u}{0.90 \times 0.85 f'_c b d^2} \right)} \right)$$

$$\rho = \frac{0.85 \times 3.5}{60} \left(1 - \sqrt{\left(1 - \frac{2 \times 14514.48 \times 12}{0.90 \times 0.85 \times 3500 \times 12 \times 9^2} \right)} \right)$$

$$= 0.0034$$

$$A_s = \rho b d = 0.0034 \times 12 \times 9 = 0.373 \text{ in}^2$$

$$\text{Spacing, } S = \frac{0.20 \times 12}{0.373} = 6.43 \approx 6 \text{ in c/c}$$

Use #4 @ 6.0 in c/c

For M_B

$$\rho = \frac{0.85 \times 3.5}{60} \left(1 - \sqrt{\left(1 - \frac{2 \times 2062.58 \times 12}{0.90 \times 0.85 \times 3500 \times 12 \times 9^2} \right)} \right)$$

$$= 0.00047$$

$$\rho_{min} = 0.0018$$

$$A_{st} = 0.0018 b t = 0.0018 \times 12 \times 9 = 0.216 \text{ in}^2$$

$$S = \frac{0.11 \times 12}{0.216} = 6.11 \approx 6 \text{ in c/c}$$

Use #3 @ 6.0 in c/c

11.2.2 Design of Cover slab:

$$DL = 150 \times (6 \div 12) = 75 \text{ psf}$$

$$LL = 60 \text{ psf}$$

$$W_u = 186 \text{ psf}$$

$$M_u = \frac{W_u L^2}{8} = \frac{186 \times 20^2}{8} = 9300 \text{ lb-ft}$$

$$d = \sqrt{\frac{9300}{0.85 \times 0.016 \times 60000 \times 12 \left(1 - 0.59 \frac{0.016 \times 60000}{3500}\right)}}$$

= 3.69 in provided, d = 5 in

(ok)

$$\rho = \frac{0.85 \times 3.5}{60} \left(1 - \sqrt{\left(1 - \frac{2 \times 9300 \times 12}{0.90 \times 0.85 \times 3500 \times 12 \times 5^2}\right)}\right)$$

$$= 0.0074$$

$$A_{st} = \rho b d = 0.0074 \times 12 \times 5 = 0.444 \text{ in}^2$$

Spacing,

$$S = \frac{0.11 \times 12}{0.444} = 2.97 \approx 3.00 \text{ in c/c}$$

Use #3@3 in c/c at mid span

Long direction steel:

$$A_{st \text{ min}} = \rho b t = 0.0018 \times 12 \times 6 = 0.129 \text{ in}^2$$

Spacing,

$$S = \frac{0.11 \times 12}{0.129} = 10.23 \approx 10 \text{ in c/c}$$

Use#3 @ 10 in c/c at long direction

11.2.3 Design of Side wall:

$$\text{Force, } p = \gamma_w h = 62.5 \times 8 = 500 \text{ psf}$$

Sort direction,

$$\text{Moment, } M = \frac{pl^2}{14} = \frac{500 \times 20^2}{14} = 14285.7 \text{ lb-ft}$$

$$d = \sqrt{\frac{14285.7 \times 12}{0.85 \times 0.016 \times 60000 \times 12 \left(1 - 0.59 \frac{0.016 \times 60}{3.5}\right)}} = 4.57 \text{ in}$$

$$\rho = \frac{0.85 \times 3.5}{60} \left(1 - \sqrt{\left(1 - \frac{2 \times 14285.7 \times 12}{0.90 \times 0.85 \times 3500 \times 12 \times 4.5^2}\right)}\right) = 0.0120$$

$$A_{st} = \rho b d = 0.0120 \times 12 \times 5 = 0.72 \text{ in}^2$$

Spacing,

$$S = \frac{0.31 \times 12}{0.72} = 5.17 \approx 5.00 \text{ in c/c}$$

Long direction,

$$\text{Moment, } M = \frac{pl^2}{14} = \frac{500 \times 30^2}{14} = 32142.8 \text{ lb-ft}$$

$$d = \sqrt{\frac{32142.8 \times 12}{0.85 \times 0.016 \times 60000 \times 12 \left(1 - 0.59 \frac{0.016 \times 60}{3.5}\right)}} = 6.85 \text{ in} \approx 7.00 \text{ in}$$

$$\rho = \frac{0.85 \times 3.5}{60} \left(1 - \sqrt{1 - \frac{2 \times 32142.8 \times 12}{0.90 \times 0.85 \times 3500 \times 12 \times 7^2}}\right) = 0.014$$

$$A_{st} = \rho b d = 0.014 \times 12 \times 7 = 1.18 \text{ in}^2$$

Spacing,

$$S = \frac{0.31 \times 12}{1.18} = 3.15 \approx 3.00 \text{ in c/c}$$

Temperature & Shrinkage steel:

Spacing,

$$S = \frac{0.11 \times 12}{0.216} = 6.11 \approx 6.0 \text{ in c/c}$$

Use #3@6 in c/c horizontally both long & short direction.

11.2.4 Reinforcement details of underground water reservoir

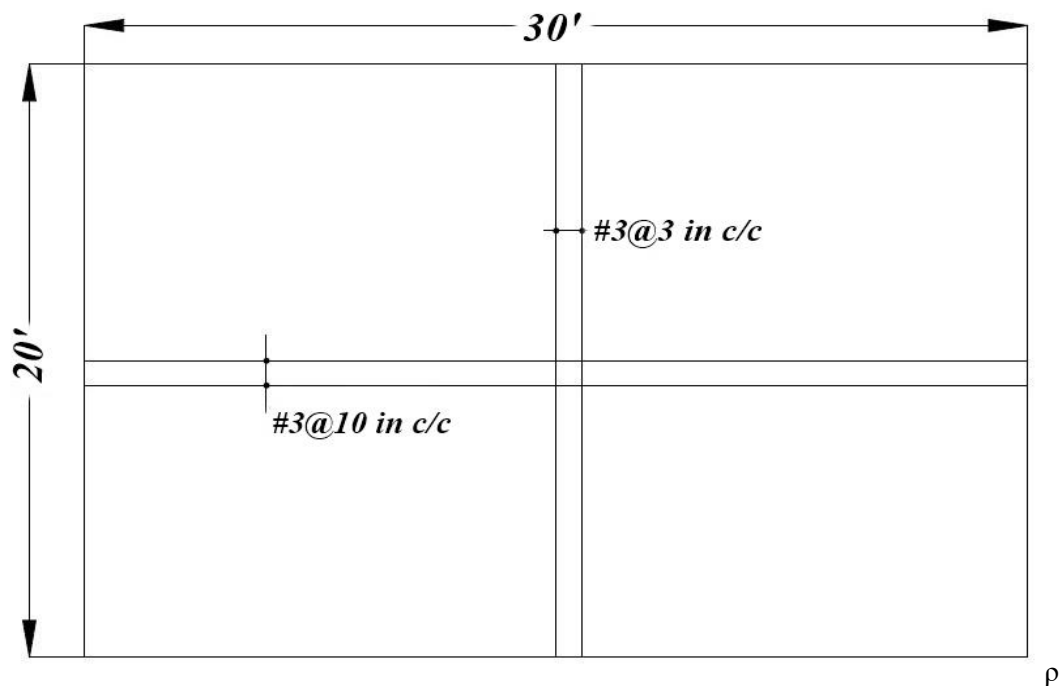

Figure 11.1: Reinforcement details of cover slab.

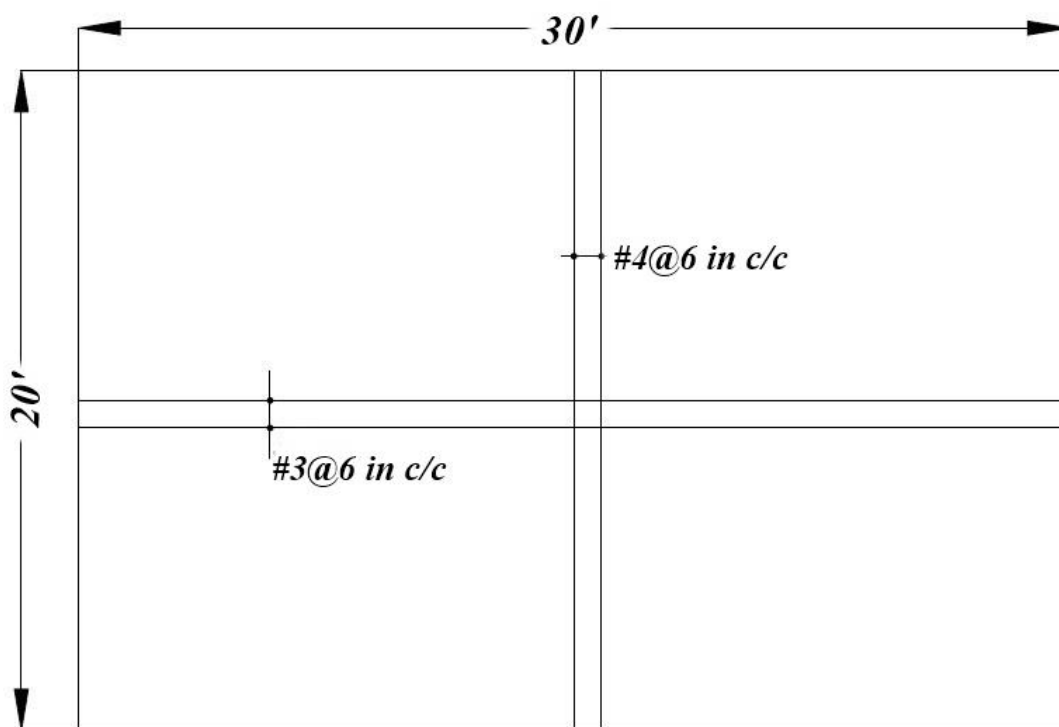

Figure 11.2: Reinforcement details of base slab

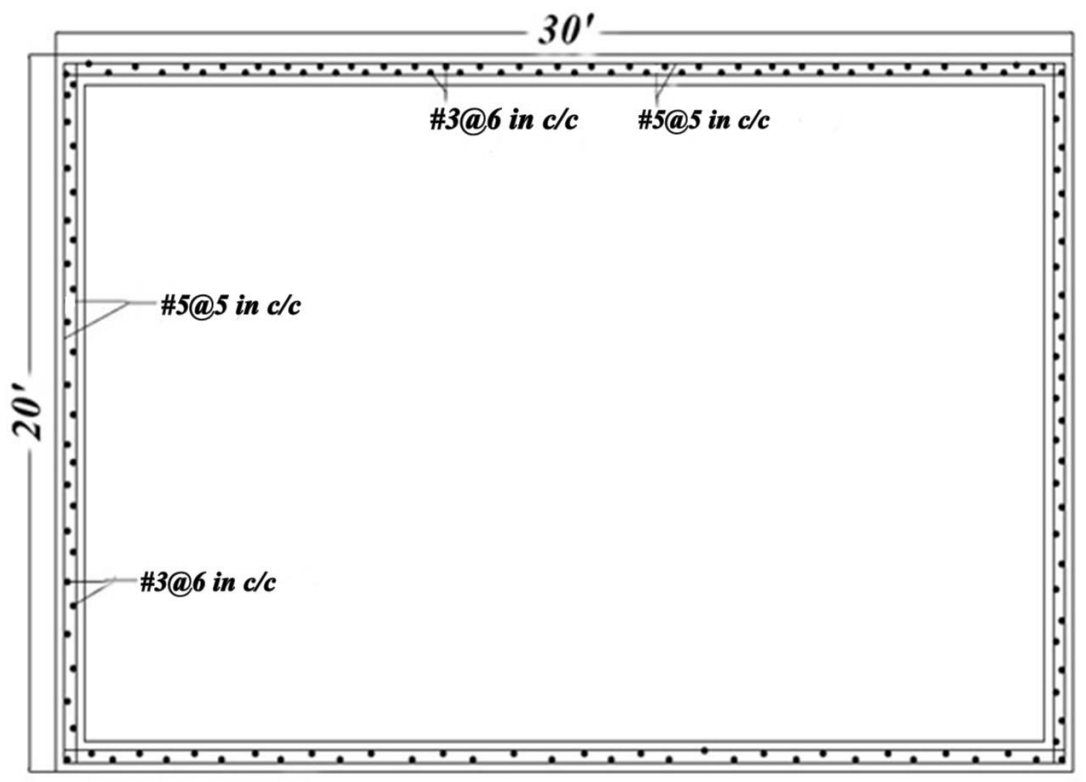

Figure 11.3: Reinforcement details of wall of the water reservoir

CHAPTER 12

DESIGN OF WATER TANK

12.1 Introduction

To fulfill the water demand of the commercial, residential and other purposes, there are two water tank with the dimension of 15 ft × 10 ft each.

12.2 Determination of water consumption

Water requirement for residential apartment:

Per capacity consumption: 235 lpcd (BNBC)

Assume, 50 persons per floor

Number of floor = 15

Total population = 50 × 15 = 750

Total consumption per day = 750 × 235 = 176250L/day

= 176.25m³/day

3 times per pumping per day $C = \frac{176.25}{3} = 58.75 \text{ m}^3/\text{day}$

Let, tank height = 7ft

Free board = 1ft

Total height = 7+1 =8ft

Select tank 15'×10'×8'

12.2.1 Wall Design

a) Determination of Bending Moment for Horizontal Bending

$$\frac{L}{B} = \frac{15}{10} = 1.5 < 2$$

$$\text{Here } h' = \frac{H}{4} = \frac{8}{4} = 2\text{ft} \geq 3.28\text{ft}$$

Select $h' = 3.28\text{ft}$

Water pressure at point D

$$W = \gamma(H - h')$$

$$= 62.5 \times (8 - 3.28) \quad \gamma = 62.5 \text{ lb/cft}$$

$$= 295 \text{ psf}$$

Fixed End Moment for Long Wall

$$\frac{Wib^2}{12} = \frac{295 \times 15^2}{12} = 5531 \text{ lb-ft}$$

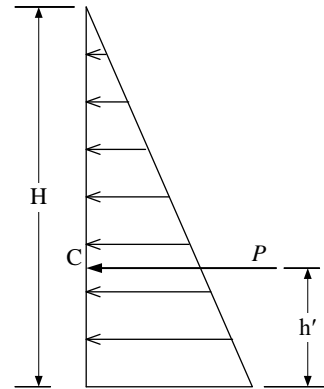

$$\text{Fixed End Moment for short Wall} = \frac{Wia^2}{12} = \frac{295 \times 10^2}{12} = 2458 \text{ lb-ft}$$

$$\text{Center Moment for Long Wall} = \frac{Wib^2}{16} = \frac{295 \times 15^2}{16} = 4148 \text{ lb-ft}$$

$$\text{Center Moment for short Wall} = \frac{Wia^2}{16} = \frac{295 \times 10^2}{16} = 1843 \text{ lb-ft}$$

b) Determination of Direct Tension

$$\text{Direct tension on Long Wall} = W \times \frac{B}{2} = 295 \times \frac{10}{2} = 1475 \text{ lb}$$

$$\text{Direct tension on short Wall} = W \times \frac{L}{2} = 295 \times \frac{15}{2} = 2212 \text{ lb}$$

c) Determination of Cantilever Moment

Moment = Force x Distance

$$= \left(\frac{1}{2} \times \gamma \times H \times h' \right) \frac{h'}{3}$$

$$= \frac{\lambda H h'^2}{6} = \frac{62.5 \times 8 \times 3.28^2}{6} = 896.53 \text{ lb-ft/ft}$$

d) Design of section

$$f'_c = 1800 \text{ psi}$$

$$f_y = 24000 \text{ psi}$$

$$E_c = 3.6 \times 10^6 \text{ psi}$$

$$k = 0.375, j = 0.875$$

Considering Bending Effect along

Design $M = 5531 \text{ lb-ft/ft}$

$$M = \frac{f_c}{2} k j b d^2$$

$$\Rightarrow 5531 \times 12 = \frac{1800}{2} \times 0.375 \times 0.875 \times 12 \times d^2$$

$$\Rightarrow 4.33''$$

$$H = 4.33 + 1 = 5.33$$

Provide $h = 5''$ $d = 4''$

e) Reinforcement of the corner of Long wall

$$A_{s1} \text{ for bending moment} = \frac{M - T_x}{f_s j d}$$

$$= \frac{5131 \times 12 - 1475 \times 1.5}{24000 \times 0.875 \times 4}$$

$$= 0.76 \text{ in}^2/\text{ft}$$

$$A_{s2} \text{ for direct tension} \frac{T}{f_s} = \frac{1475}{24000} = 0.061 \text{ in}^2/\text{ft}$$

$$\text{Total steel requirement} = 0.76 + 0.061 = 0.821 \text{ in}^2/\text{ft}$$

f) Reinforcement of the middle of Long wall

$$As1 \text{ for bending moment} = \frac{M - T_x}{f_s jd}$$

$$= \frac{2458 \times 12 - 1475 \times 1.5}{24000 \times 0.875 \times 4}$$

$$= 0.32 \text{ in}^2/\text{ft}$$

$$As2 \text{ for direct tension} \frac{T}{f_s} = \frac{1475}{24000} = 0.061 \text{ in}^2/\text{ft}$$

$$\text{Total steel requirement} = 0.32 + 0.061 = 0.381 \text{ in}^2/\text{ft}$$

g) Reinforcement of the corner of short wall

$$As1 \text{ for bending moment} = \frac{M - T_x}{f_s jd} = \frac{4148 \times 12 - 2212 \times 1.5}{24000 \times 0.875 \times 4} = 0.55 \text{ in}^2/\text{ft}$$

$$As2 \text{ for direct tension} \frac{T}{f_s} = \frac{2212}{24000} = 0.092 \text{ in}^2/\text{ft}$$

$$\text{Total steel requirement} = 0.092 + 0.55 = 0.64 \text{ in}^2/\text{ft}$$

h) Reinforcement of the middle of short wall

$$As1 \text{ for bending moment} = \frac{M - T_x}{f_s jd}$$

$$= \frac{1843 \times 12 - 2212 \times 1.5}{24000 \times 0.875 \times 4}$$

$$= 0.22 \text{ in}^2/\text{ft}$$

$$As2 \text{ for direct tension} \frac{T}{f_s} = \frac{2212}{24000} = 0.092 \text{ in}^2/\text{ft}$$

$$\text{Total steel requirement} = 0.092 + 0.22 = 0.312 \text{ in}^2/\text{ft}$$

i) Binder Reinforcement in the wall

$$\text{Minimum steel} = 0.002bh = 0.002 \times 12 \times 5 = 0.12 \text{ in}^2/\text{ft}$$

Use 10mm @ 11" c/c

j) Detailing of steel in the wall

Long Wall

Middle: 12mm @ 7" c/c alt/ ckd

$$\text{Provided, } \frac{0.2 \times 12}{7} = 0.34 \text{ in}^2/\text{ft}$$

Corner: 2-12mm in between ckd

$$\text{Provided, } \frac{3 \times 0.2 \times 12}{13} = 0.55 \text{ in}^2/\text{ft}$$

Short Wall

Middle: 10mm @ 8.5" c/c alt/ ckd

$$\text{Provided, } \frac{0.11 \times 12}{8.5} = 0.155 \text{ in}^2/\text{ft}$$

Corner: 10mm @ 6.5" c/c

$$\text{Provided, } \frac{0.11 \times 12}{6.5} = 0.20 \text{ in}^2/\text{ft}$$

12.3 Reinforcement Details of Water Tank

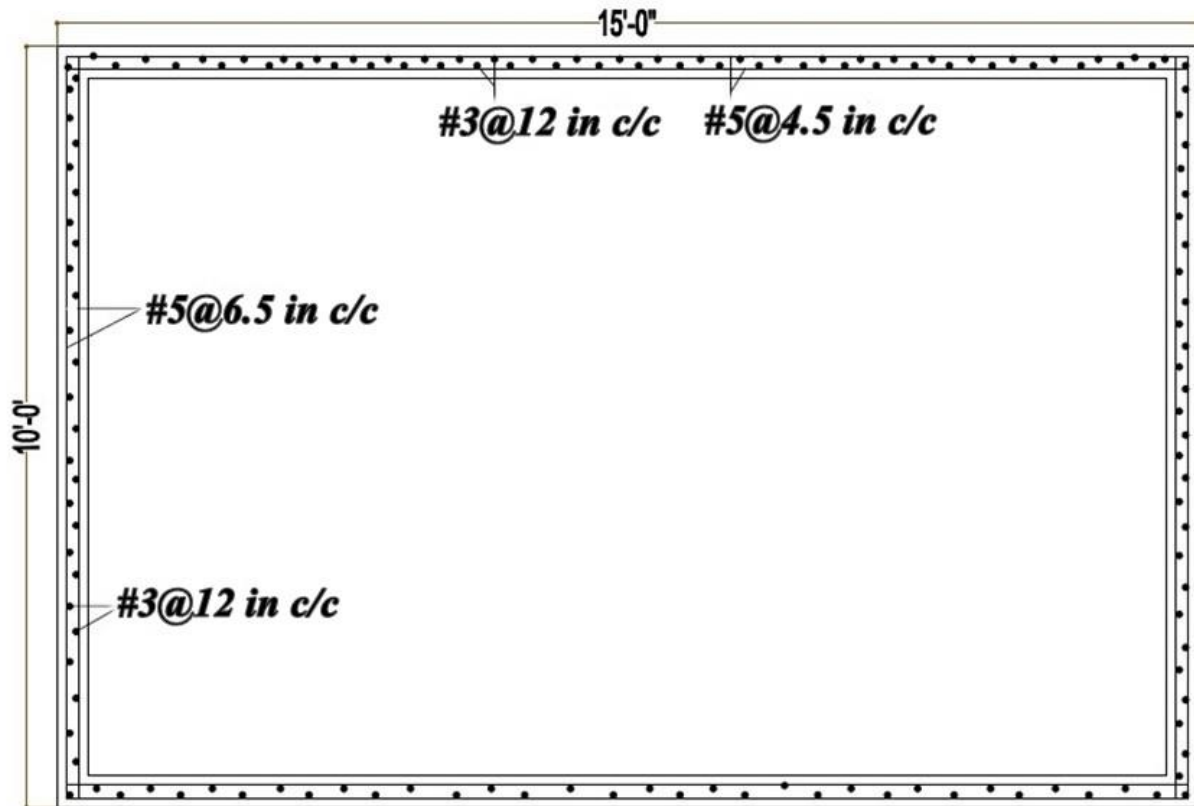

Figure 12.1: Reinforcement details of wall of the tank.

CHAPTER 13

CONCLUSIONS & RECOMMENDATIONS

13.1 Conclusions

A Twelve storied residential building was planned and designed as per ACI and BNBC Codes where lateral loads were also considered. This study reveals that

- Strength properties of materials must be checked before construction to achieve required design strength capacity.
- Knowledge about computational method that the analytical software implies for computation is very useful to develop structural model accurately.
- Seismic design requires more detailing works to achieve structural ductility and required strength due to earthquake induced loads for structural members.

13.2 Recommendations for future work

Based on the scopes and limitations of this study, few recommendations which can be proposed for further studies are following.

- Beam to column joints which were not designed in the study are important to take in consideration to design a high rise building.
- Torsion of the whole building structure due to earthquake excitation should be considered in the seismic resistant design. It was not covered in this study and recommended for future study.
- Foundation design is very important for super structure but it is not cover in the study and recommended for future study.
- Cost comparison is an important component for all types of projects. It must be done before finalizing the structural design of a building. It is not considered for the study and recommended for future study.

REFERENCE

1. “Bangladesh National Building Code”, 1st Edition, City Art Press, Dhaka, Bangladesh, 1993.
2. “American Concrete Institute Building Design Code”, *ACI*, New York, USA, 2014.
3. “Design of Concrete Structures”, 14th Edition, Nilson A. H., Darwin D. and Dolan, C. W. McGraw-Hill Publishing Company Ltd, New Delhi, India, 2010.
4. “Reinforced Concrete Fundamentals”, Ferguson P. M., Breen J. E. and Jirsa J. O.; 5th Edition, John Wiley & Sons, Inc., New York, 1987.
5. “Reinforced Concrete Design”, 3rd Edition, Everard N. J.; SCHAUM’S outlines, Tata McGraw-Hill Publishing Company Ltd, New Delhi, India, 2004.
6. Dr. Ali Ahmed, “*Analysis under lateral loads and earthquake resistant design of structural members of buildings*”, Special lecture notes for Project and Thesis of undergraduate students, 2018.
7. Dr. Ali Ahmed, “Design of underground water reservoir and water tank”, Lecture notes on *Analysis and Design of a Multistoried Residential Building* for course CE – 412: Structural Analysis & Design Sessional II, 2015.
8. Mark Fintel, Handbook of Concrete Engineering, 2nd edition.
9. Khan and Rahman, Reinforced Concrete Manual and Building plan , 2nd Edition
10. <http://www.scribd.com/doc/8524750/A-Study-on-Performance-of-Existing-Building-Using-Ordinary-Moment-Resisting-Frame-in-Seismic-Zone2A>
11. Computers and Structures information from <https://www.csiamerica.com>

Appendix 1: Areas of groups of standard bars (in²) and SI Conversion factors

Appendix 1: Minimum Uniformly Distributed and Concentrated Loads		
Occupancy or Use	Uniform psf (kN/m ²)	Concentration lb (kN)
Apartments (see residential)		
Access floor systems		
Office use	50 (2.4)	2,000 (8.9)
Computer use	100 (4.79)	2,000 (8.9)
Armories and drill rooms		
Assembly areas and theaters		
Fixed seats (fastened to floor)	60 (2.87)	
Lobbies	100 (4.79)	
Movable seats	100 (4.79)	
Platforms (assembly)	100 (4.79)	
Stage floors	150 (7.18)	
Balconies (exterior)		
On one- and two-family residences only, and not exceeding 100 ft ² (9.3 m ²)	60 (2.87)	
Bowling alleys, poolrooms and similar recreational areas		
Catwalks for maintenance access	40 (1.92)	300 (1.33)
Corridors		
First floor	100 (4.79)	
Other floors, same as occupancy served except as indicated		
Dance halls and ballrooms		
Decks (patio and roof)		
Same as area served, or for the type of occupancy accommodated		
Dining rooms and restaurants		
Dwellings (see residential)		
Elevator machine room grating [on area of 4 in. ² (2,580 mm ²)]		300 (1.33)
Finish light floor plate construction [on area of 1 in. ² (645 mm ²)]		200 (0.89)
Fire escapes		
On single-family dwellings only	40 (1.92)	
Fixed Ladders		
Garages (passenger cars only)		
Trucks and buses	50 (2.40)	
Grandstands (see stadium and arena bleachers)		
Gymnasiums, main floors and balconies		
Handrails, guardrails and grab bars	100 (4.79) ⁴	
Hospitals		
Operating rooms, laboratories	60 (2.87)	1,000 (4.45)
Private rooms	40 (1.92)	1,000 (4.45)
Wards	40 (1.92)	1,000 (4.45)
Corridors above first floor	80 (3.83)	1,000 (4.45)
Hotels (see residential)		
Libraries		
Reading rooms	60 (2.87)	1,000 (4.45)
Stack rooms	150 (7.18) ³	1,000 (4.45)
Corridors above first floor	80 (3.83)	1,000 (4.45)
Manufacturing		
Light	125 (6.00)	2,000 (8.90)
Heavy	250 (11.97)	3,000 (13.40)
Marquees and Canopies		
75 (3.59)		
Office Buildings		
File and computer rooms shall be designed for heavier loads based on anticipated occupancy		
Lobbies and first floor corridors	100 (4.79)	2,000 (8.90)
Offices	50 (2.40)	2,000 (8.90)
Corridors above first floor	80 (3.83)	2,000 (8.90)

Appendix 2: Areas of groups of standard bars (in²) and SI Conversion factors

REINFORCING STEEL BARS

ASTM A615/A706 CHART FOR REINFORCING STEEL BARS						
Bar Size Designation Inch-Pound [Soft Metric]	Nominal Weight lb./ft. (kg/m)		Nominal Dimensions			
			Diameter in. (mm)		Cross Sectional Area in ² (mm ²)	
#3 [10]	0.376	(.560)	0.375	(9.5)	0.11	(71)
#4 [13]	0.668	(.994)	0.500	(12.7)	0.20	(129)
#5 [16]	1.043	(1.552)	0.625	(15.9)	0.31	(199)
#6 [19]	1.502	(2.235)	0.750	(19.1)	0.44	(284)
#7 [22]	2.044	(3.042)	0.875	(22.2)	0.60	(387)
#8 [25]	2.670	(3.973)	1.000	(25.4)	0.79	(510)
#9 [29]	3.400	(5.060)	1.128	(28.7)	1.00	(645)
#10 [32]	4.303	(6.404)	1.270	(32.3)	1.27	(819)
#11 [36]	5.313	(7.907)	1.410	(35.8)	1.56	(1006)
#14 [43]	7.65	(11.38)	1.693	(43.0)	2.25	(1452)
#18 [57]	13.60	(20.24)	2.257	(57.3)	4.00	(2581)

CAN/CSA-G30.18-M92 CHART FOR REINFORCING STEEL BARS				
Bar Size Designation Metric	Nominal Mass kg/m	Nominal Dimensions		Comparison To A615
		Diameter mm	Cross Sectional Area mm ²	
10M	0.785	11.3	100	20% < # 4
15M	1.570	16.0	200	SAME AS # 5
20M	2.355	19.5	300	6.8% > # 6
25M	3.925	25.2	500	1.3% < # 8
30M	5.495	29.9	700	9% > # 9
35M	7.850	35.7	1000	0.6% < # 11
45M	11.775	43.7	1500	3.5% > # 14
55M	19.625	56.4	2500	3% < # 18
UNIT CONVERSIONS				
kilogram (kg) = 2.2046 lb.		1 kilogram/meter (kg/m) = .6719 lb./ft.		
1 millimeter (mm) = .03937 in.		1 metric/ton = 1000 kg		
1 meter (m) = 3.281 ft.		= 2204.6 lb		
1 square millimeter (mm ²) = .00155 in. ²		1 megapascal (MPa) = 1 Newton/mm ²		
		= 145.03 psi		

Appendix 3: Column strength interaction diagram with $\gamma = 0.90$

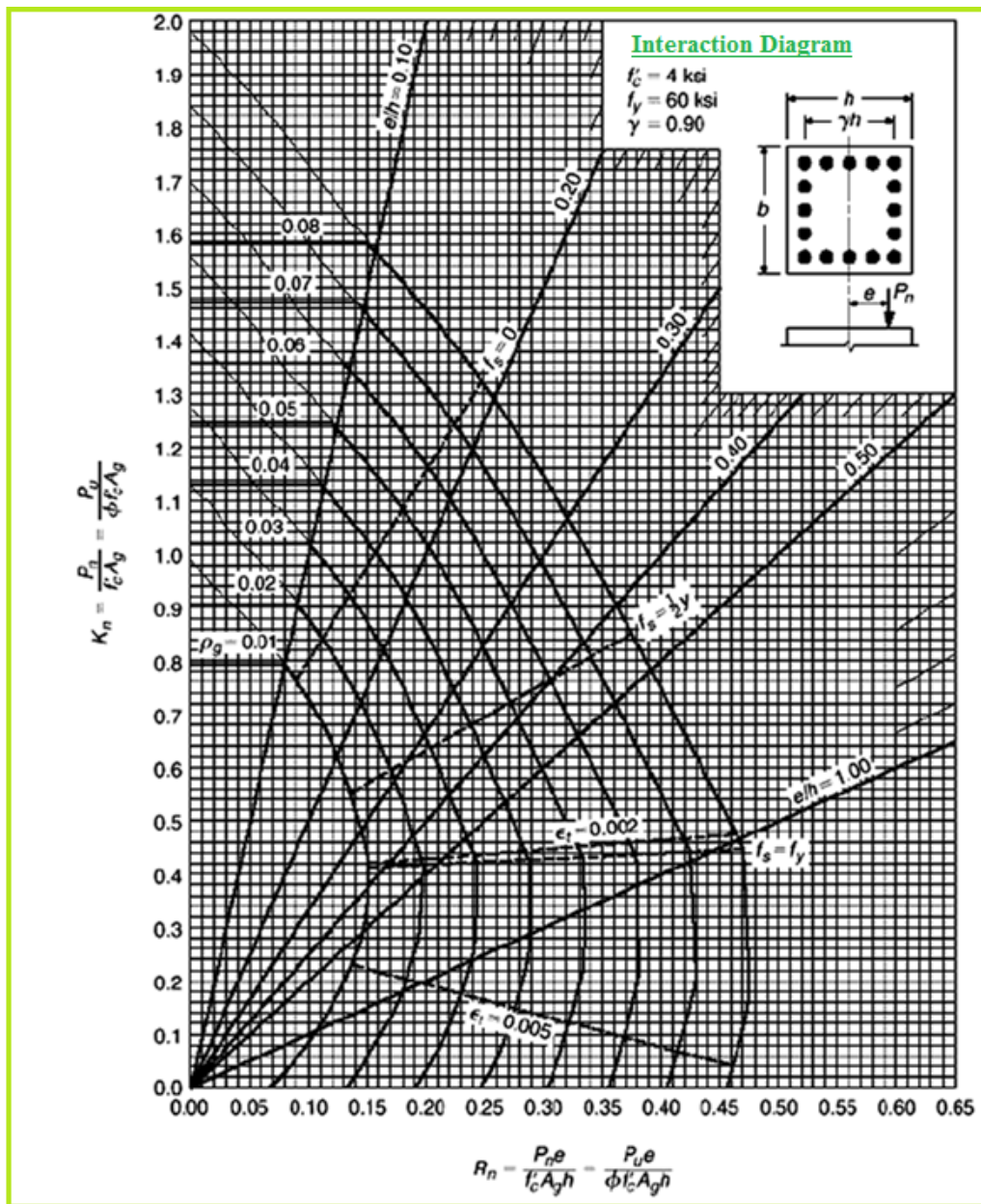

Appendix 4: Column strength interaction diagram with $\gamma = 0.80$

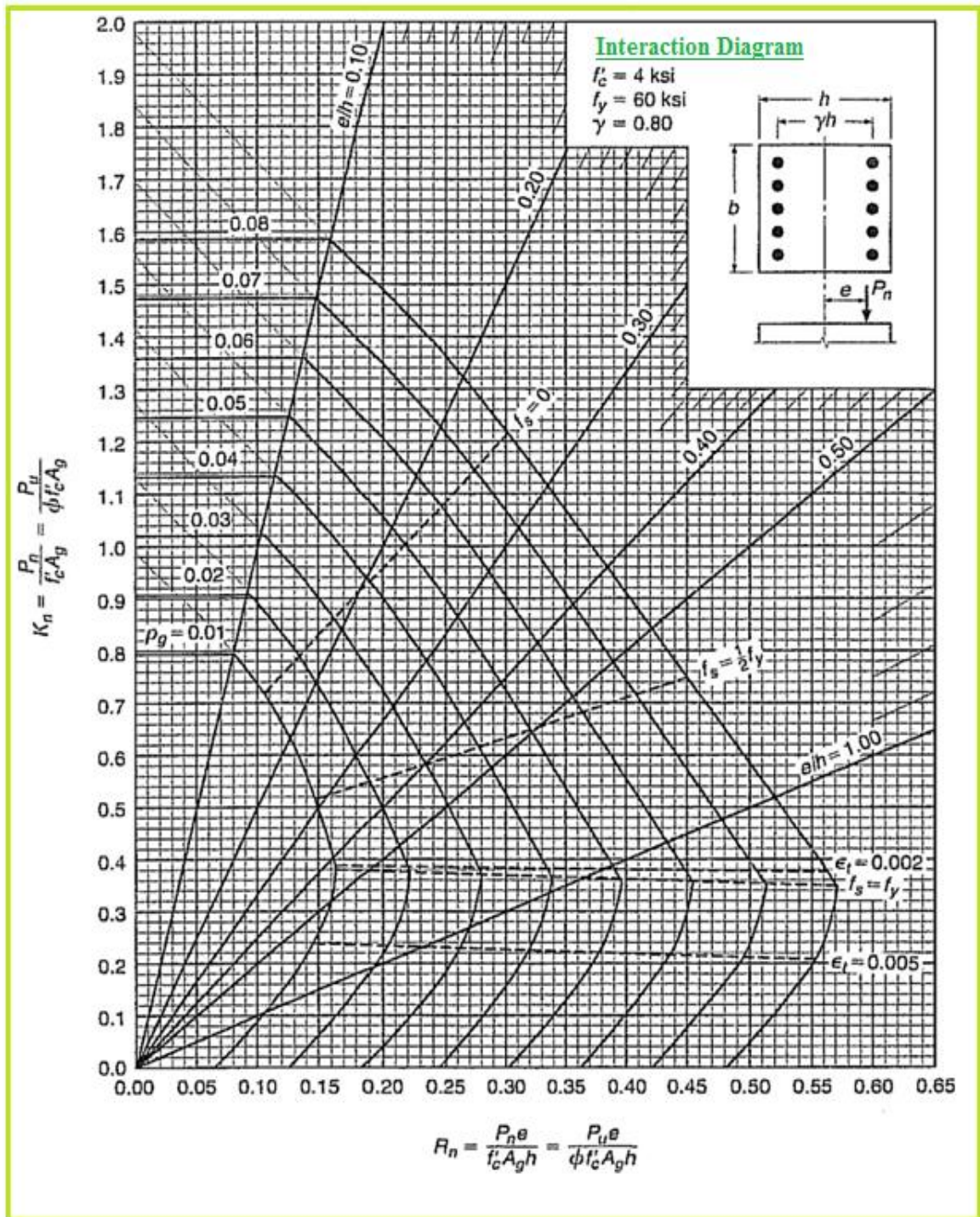

Appendix 5: Minimum & Maximum Steel Ratios as per ACI Code

Compressive strength of concrete f'_c psi	Minimum Steel Ratios ρ_{min}	Maximum Steel Ratios ρ_{max}
$f_y = 4000$ psi		
3000	0.0050	0.0278
4000	0.0050	0.0317
5000	0.0053	0.0437
6000	0.0058	0.0491
$f_y = 5000$ psi		
3000	0.0040	0.0206
4000	0.0040	0.0275
5000	0.0042	0.0324
6000	0.0046	0.0364
$f_y = 6000$ psi		
3000	0.0033	0.0160
4000	0.0033	0.0214
5000	0.0035	0.0252
6000	0.0039	0.0283
$f_y = 7500$ psi		
3000	0.0027	0.0116
4000	0.0027	0.0155
5000	0.0028	0.0183
6000	0.0031	0.0205

Appendix 6: Cross-section Area of reinforcement Bars per foot of slab (in^2)

Bar Spacing (in)	Bar number			
	#3	#4	#5	#6
2.0	0.66	1.20	1.86	
2.5	0.53	0.96	1.49	2.11
3.0	0.44	0.80	1.24	1.76
3.5	0.38	0.69	1.06	1.51
4.0	0.33	0.60	0.93	1.32
4.5	0.29	0.53	0.83	1.17
5.0	0.26	0.48	0.74	1.06
5.5	0.24	0.44	0.68	0.96
6.0	0.22	0.40	0.62	0.88
6.5	0.20	0.37	0.57	0.81
7.0	0.19	0.34	0.53	0.75
7.5	0.18	0.32	0.50	0.70
8.0	0.17	0.30	0.47	0.66
8.5	0.16	0.28	0.44	0.62
9.0	0.15	0.27	0.41	0.59
9.5	0.14	0.25	0.39	0.56
10.0	0.13	0.24	0.37	0.53
10.5	0.13	0.23	0.35	0.50
11.0	0.12	0.22	0.34	0.48
11.5	0.11	0.21	0.32	0.46
12.0	0.11	0.20	0.31	0.44
12.5	0.11	0.19	0.30	0.42
13.0	0.10	0.18	0.29	0.41
13.5	0.10	0.18	0.28	0.39
14.0	0.09	0.17	0.27	0.38
14.5	0.09	0.17	0.26	0.36
15.0	0.09	0.16	0.25	0.35
15.5	0.09	0.15	0.24	0.34
16.0	0.08	0.15	0.23	0.33
16.5	0.08	0.15	0.23	0.32
17.0	0.08	0.14	0.22	0.31
17.5	0.08	0.14	0.21	0.30
18.0	0.07	0.13	0.21	0.29

Appendix 7: Combined Height and Exposure Coefficient, C_z

Height above ground level, Z (m)	Coefficient, C_z		
	Exposure (A)	Exposure (B)	Exposure (C)
0-4.5	0.368	0.801	1.196
6.0	0.415	0.866	1.263
9.0	0.497	0.972	1.370
12.0	0.565	1.055	1.451
15.0	0.624	1.125	1.517
18.0	0.677	1.185	1.573
21.0	0.725	1.238	1.623
24.0	0.769	1.286	1.667
27.0	0.810	1.330	1.706
30.0	0.849	1.371	1.743
35.0	0.909	1.433	1.797
40.0	0.965	1.488	1.846
45.0	1.017	1.539	1.890
50.0	1.065	1.586	1.930
60.0	1.155	1.671	2.002
70.0	1.237	1.746	2.065
80.0	1.313	1.814	2.120
90.0	1.383	1.876	2.171
100.0	1.450	1.934	2.217
110.0	1.513	1.987	2.260
120.0	1.572	2.037	2.299
130.0	1.629	2.084	2.337
140.0	1.684	2.129	2.371
150.0	1.736	2.171	2.404
160.0	1.787	2.212	2.436
170.0	1.835	2.250	2.465
180.0	1.883	2.287	2.494
190.0	1.928	2.323	2.521
200.0	1.973	2.357	2.547
220.0	2.058	2.422	2.596
240.0	2.139	2.483	2.641
260.0	2.217	2.541	2.684
280.0	2.910	2.595	2.724
300.0	2.362	2.647	2.762

Appendix 8: Basic Wind Speed for Selected Location in Bangladesh

Location	Basic Wind Speed (Km/h)	Location	Basic Wind Speed (Km/h)
Angarpota	150	Lalmonirhat	204
Bagerhat	252	Madaripur	220
Bandarban	200	Magura	208
Barguna	260	Manikganj	185
Barisal	256	Meherpur	185
Bhola	225	Moheshkhali	260
Bogra	198	Moulvibazar	168
Brahmanbaria	180	Munshiganj	184
Chandpur	160	Mymensingh	217
ChapaiNawabganj	130	Naogaon	175
Chhtagongi	260	Narail	222
Chuaddanga	198	Narayanganj	195
Comilla	196	Narsinghdi	190
Cox's Bazar	260	Natore	198
Dahagram	150	Netrokona	210
Dhaka	210	Nilphamari	140
Dinajpur	130	Noakhali	184
Faridpur	202	Pabna	202
Feni	205	Panchagarh	130
Gaibandha	210	Patuikhali	260
Gazipur	215	Pirojpur	260
Gopalganj	242	Rajbauri	188
Habiganj	172	Rajshahi	155
Hatiya	260	Rangamati	180
Ishurdi	225	Rangpur	209
Joypurhat	180	Satkhira	183
Jamalpur	180	Shariatpur	198
Jessore	205	Sherpur	200
Jhalakati	260	Sirajganj	160
Jhenaidah	208	Srimangal	160
Khagrachhari	180	St.Martin's Island	260
Khulna	238	Sunamganj	195
Kutubdia	260	Sylhet	195
Kishoreganj	207	Sandwip	260
Kurigram	210	Tangail	160
Kushti	215	Teknaf	260
Lakshmipur	162	Thakurgaon	130

Appendix 9: Gust Response Factors, G_h and G_z

Height above ground level, Z (m)	G_h and G_z		
	Exposure (A)	Exposure (B)	Exposure (C)
0-4.5	1.654	1.321	1.154
6.0	1.592	1.294	1.140
9.0	1.511	1.258	1.121
12.0	1.457	1.233	1.107
15.0	1.418	1.215	1.097
18.0	1.388	1.201	1.089
21.0	1.363	1.189	1.082
24.0	1.342	1.178	1.077
27.0	1.324	1.170	1.072
30.0	1.309	1.162	1.067
35.0	1.287	1.151	1.061
40.0	1.268	1.141	1.055
45.0	1.252	1.133	1.051
50.0	1.238	1.126	1.046
60.0	1.215	1.114	1.039
70.0	1.196	1.103	1.033
80.0	1.180	1.095	1.028
90.0	1.166	1.087	1.024
100.0	1.54	1.081	1.020
110.0	1.114	1.075	1.016
120.0	1.134	1.070	1.013
130.0	1.126	1.065	1.010
140.0	1.118	1.061	1.008
150.0	1.111	1.057	1.005
160.0	1.104	1.053	1.003
170.0	1.098	1.049	1.001
180.0	1.092	1.046	1.000
190.0	1.087	1.043	1.000
200.0	1.082	1.040	1.000
220.0	1.073	1.035	1.000
240.0	1.065	1.030	1.000
260.0	1.058	1.026	1.000
280.0	1.051	1.022	1.000
300.0	1.045	1.018	1.000

- Note :**
- For main wind-force resisting systems, use building or structure height h for z .
 - Linear interpolation is acceptable for intermediate values of z .

Appendix 10: Seismic Zone Coefficient, Z

Seismic Zone	Zone Coefficient
1	0.075
2	0.15
3	0.25

Appendix 11: Structure Importance Coefficients, I , I'

Structure Importance Category (See Appendix-X for Occupancy)	Structure Importance Coefficients	
	I	I'
1. Essential facilities	1.25	1.50
2. Hazardous facilities	1.25	1.50
3. Special occupancy structures	1.00	1.00
4. Standard occupancy structures	1.00	1.00
5. Low risk structures	1.00	1.00

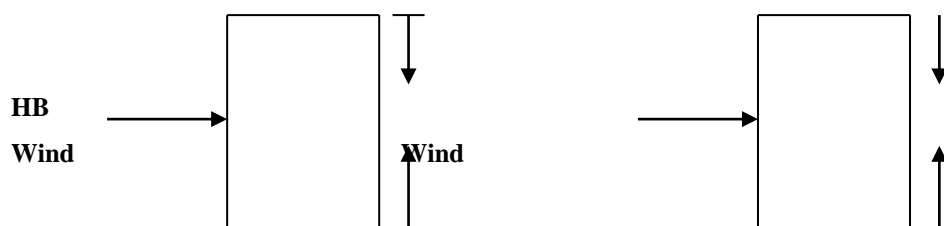
Appendix 12: Overall Pressure Coefficient C_p for rectangular building with flat roofs.

Elevation Plan

H/B	L/B					
	0.1	0.5	0.65	1.0	2.0	≥ 3.0
≤ 5	1.40	1.45	1.55	1.40	1.15	1.10
10.0	1.55	1.85	2.00	1.70	1.30	1.15
20.0	1.80	2.25	2.55	2.00	1.40	1.20
≥ 40.0	1.95	2.50	2.80	2.00	1.60	1.25

Appendix 13: Site Coefficient, *S* for seismic Lateral Forces

Site soil Characteristics		Coefficient, <i>S</i>
Type	Description	
S₁	<ul style="list-style-type: none"> ➤ A soil profile with either: <ul style="list-style-type: none"> ❖ A rock-like material characterized by a shear-wave velocity greater than 762 m/s or by other suitable means of classification, or ❖ Stiff or dense soil condition where the soil depth is less than 61 meters. 	1.0
S₂	<ul style="list-style-type: none"> ➤ A soil profile with dense or stiff soil condition, where the soil depth exceeds 61 meters. 	1.2
S₃	<ul style="list-style-type: none"> ➤ A soil profile 21 meters or more in depth and containing more than 6 meters of soft to medium stiff clay but not more than 12 meters of soft clay. 	1.5
S₄	<ul style="list-style-type: none"> ➤ A soil profile containing more than 12 meters of soft clay characterized by a shear wave velocity less than 152 m/s. 	2.0

Appendix 14: Response Modification Coefficient for Structural System, R

Basic Structural System	Description of lateral Force Resisting System	R
Bearing Wall System	➤ Light framed walls with shear panels	8
	❖ Plywood walls for structures,	6
	❖ 3 storey or less	
	❖ All other light framed walls	6
	➤ Shear walls	6
	❖ Concrete	4
	❖ Masonry	
➤ Light steel framed bearing walls with tension only bracing		
➤ Braced frames where bracing carries gravity loads	6	
❖ Steel	4	
❖ Concrete	4	
❖ Heavy timber		
Basic Structural System	Description of lateral Force Resisting System	R
Building Frame System	➤ Steel eccentric braced frame	10
	➤ Light framed walls with shear panels	
	❖ Plywood walls for structures 3- storey's or less	
	❖ All other light framed walls	
	➤ Shear walls	9
	❖ Concrete	7
	❖ Masonry	8
➤ Concentric braced frame	8	
❖ Steel	8	
❖ Concrete	8	
❖ Heavy timber	8	
Moment Resisting Frame System	➤ Special moment resisting frame	12
	❖ Steel	12
	❖ Concrete	8
	➤ Intermediate moment resisting frame concrete	
	Ordinary moment resisting frame	
❖ Steel	6	
❖ Concrete	5	
Dual System	➤ Shear walls	
	❖ Concrete with steel or concrete SMRF	12
	❖ Concrete with steel OMRF	6
	❖ Concrete with concrete IMRF	9
	❖ Masonry with steel or concrete SMRF	8
	❖ Masonry with steel OMRF	6
	❖ Masonry with concrete IMRF	7
	➤ Steel EBF	
	❖ With steel SMRF	12
	❖ With steel OMRF	6
	➤ Concentric braced frame	
	❖ Steel with steel SMRF	10
❖ Steel with steel OMRF	6	
❖ Concrete with concrete SMRF	9	
❖ Concrete with concrete IMRF	6	

Appendix 15: ACI standard bend and cutoff points for reinforcing bars

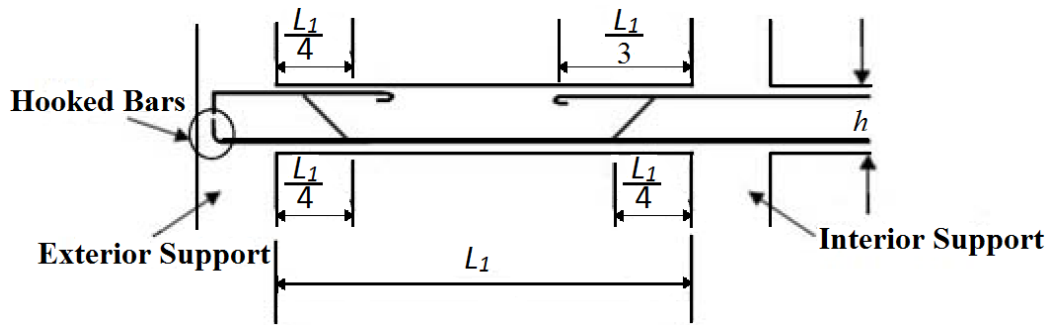

a) Bend points with fixed exterior support

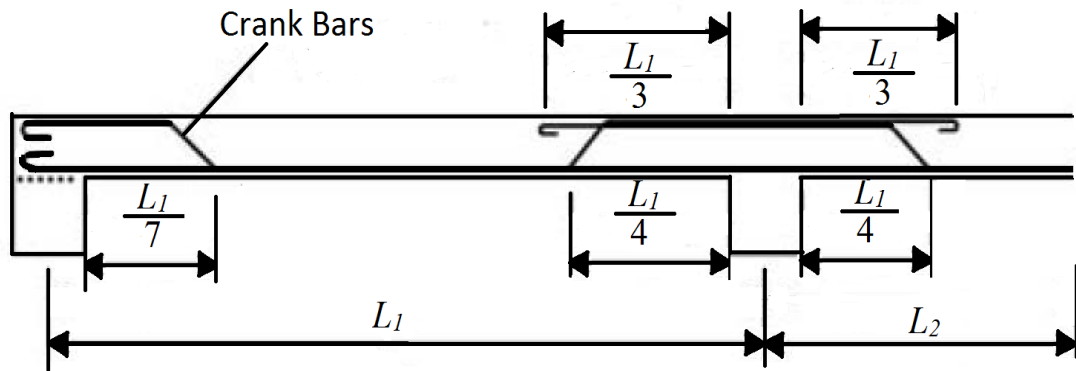

b) Bend points with exterior simply

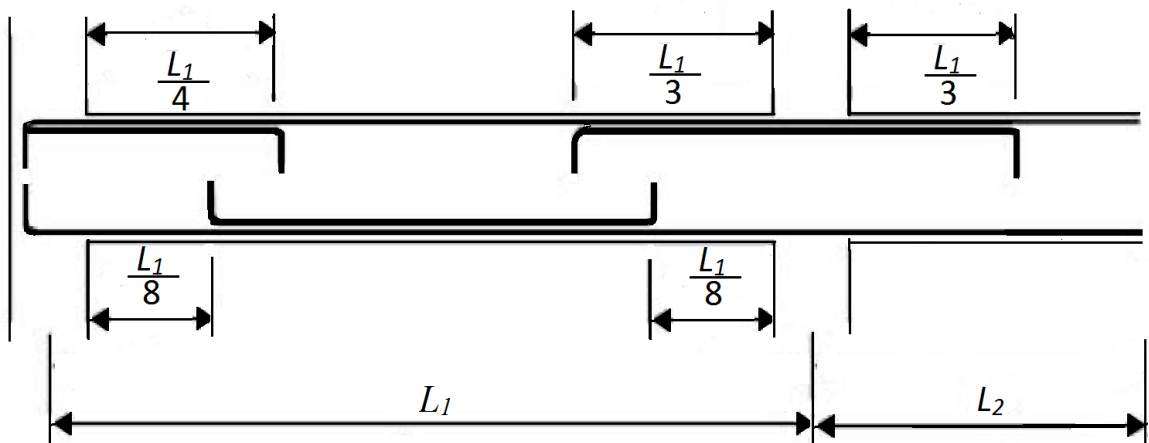

c) Cutoff points for fixed supported

Appendix 16: Dimensions and bend radii of hooked bars for tensile reinforcement

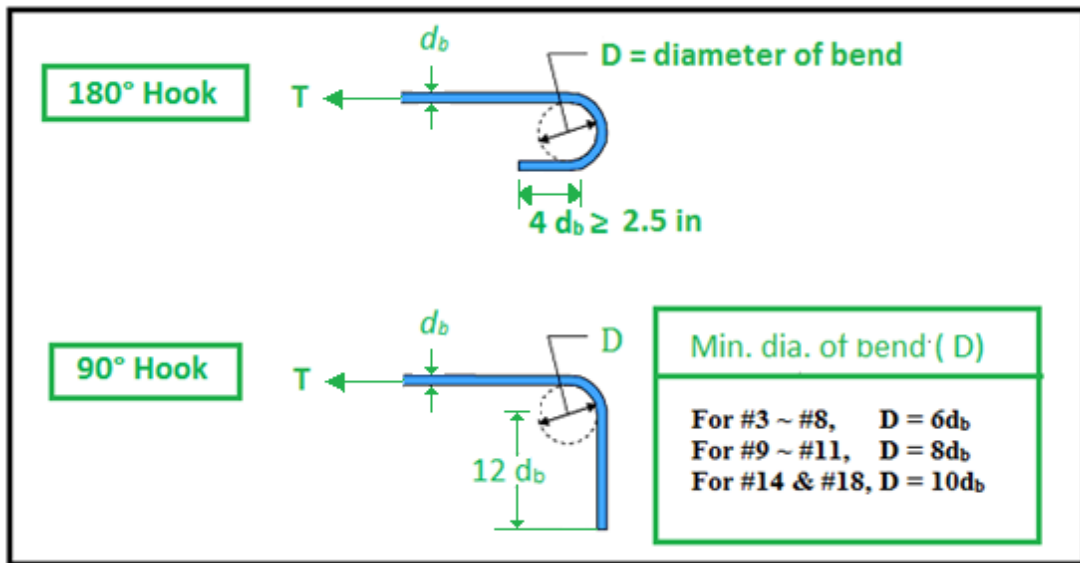

Appendix 17: Dimensions and bend radii of hooked bars for ties/stirrups

